

Towards Blue Ocean

JAPMAS STEEL SDN BHD

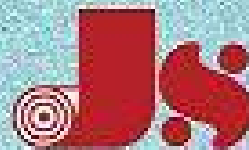

CompanyBackground

Japmas Steel Sdn Bhd traces its roots back to the 1964, when its holding company, Lee Chuan Guan Steel Sdn Bhd (formerly known as Lee Chuan Guan Hardware Sdn Bhd) was initiated business as a retail hardware shop in Johor Bahru.

The company engaged into the steel coil services in 1990 and diversified into steel pipe manufacturing subsequently with various roll-formed production lines since the past decade. In 2004, Japmas Steel received ISO 9001:2000 for the manufacture of steel pipes, hollow sections, roll-formed steel products, the processing of steel sheets and coils.

Today, Japmas Steel has grown as the leading pipe manufacturer in Southern Peninsular Malaysia which equipped with the state-of-the-art machineries cater from the primary coil slitting stage throughout pipe production strengthen with ample storage space located in strategy location that just 8km away from the major port. The great location of Japmas Steel is considered as an advantage to complement the company's export business to both Pacific and Indian Ocean regions.

Japmas Steel's capabilities in product development are based on its advanced in-house facilities and supporting by the foreign expertise with relevant experiences in pipe and tube applications, research and development as well as manufacturing processes. Undoubtedly, the company is committed in providing quality products at competitive price level to customers.

For more information on coil services, please refer to our coil services catalogue



Manufacturing Features

03



Stabilized quality

All Japmas Steel's products, manufactured under a rigid quality control system covering the whole production process from steel slitting to final finishing, incorporate the company's emerging technology and years of experience, and enjoy a good reputation because of their reliable quality and technical support.

Wide choice of sizes

Japmas Steel's arc welded tubes and pipes are available in a free choice of sizes, including diameter and wall thickness, because the pipe mill is fully back by its own coil service centre.



Strict process control and reliable service system

Manufacturing all products under its severe process control system, Japmas Steel can meet the most exacting customer demands for delivery time. Japmas Steel also provides its customers with expert advice and reliable technical service on the basis of its rich experience and R & D work.

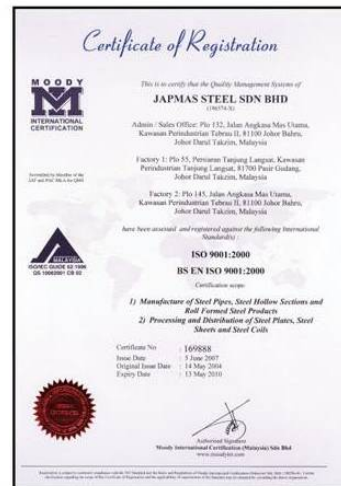

Variety of steel sections

In addition to steel products comply to JIS, ASTM & BS etc. Japmas Steel also provides other series of steel materials for different application of steel pipes and tubes that specially required by vary customers.





Pipe Mill Processing Chart

TUBE MILL

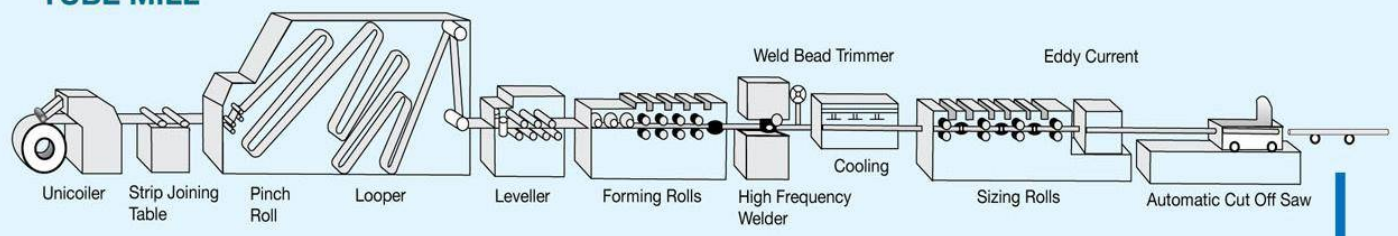

GALVANISING PLANT

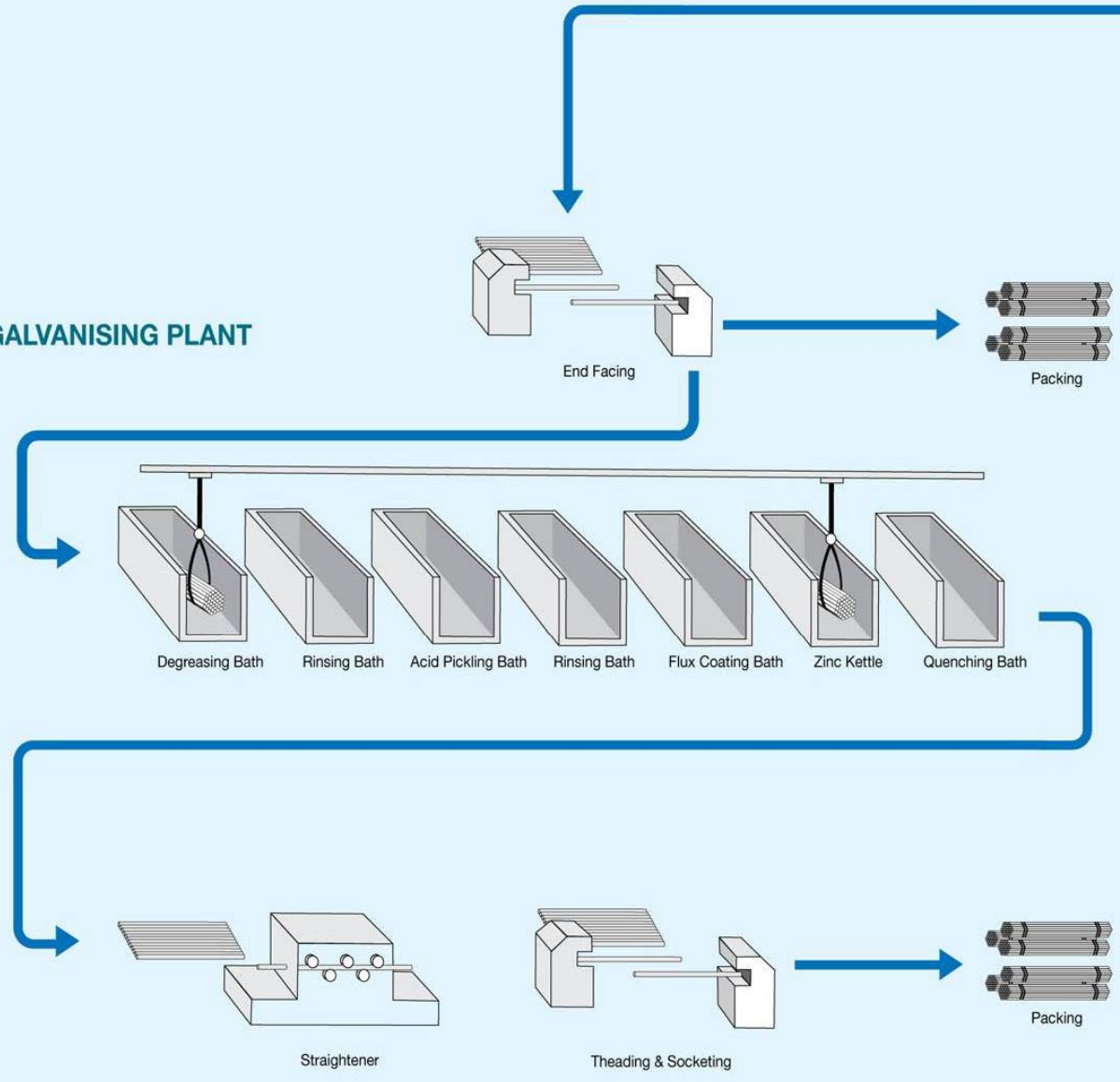

Products Summary Table



05

Specification Table Of Steel Sections

CLASSIFICATION	STANDARD		APPLICATION	MAX. CHEMICAL REQUIREMENT (%)					MIN. PHYSICAL REQUIREMENT		
	SPECIFICATION			C	Mn	Si	P	S	Tensile (Mpa)	Yield (Mpa)	Elongation (%)
Circular Hollow Sections	BS 1387	L	Carbon steel pipe for ordinary uses, water pipe and structural purpose	0.20	1.20	-	0.045	0.045	320	195	20
		M									
		H									
	Mfg Standard	AA	Carbon steel pipe for Ordinary usage.	0.20	1.20	+	0.045	0.045	270	170	20
	BSEN10219 Mfg Standard	Part 2	Carbon steel pipe for structural purpose	0.20	1.20	-	0.045	0.045	340-470	235	27
	BS 1139		Carbon steel tube for scaffolding purpose	0.20	-	0.30	0.05	0.05	340	235	24
	JIS G 3444 Mfg Standard	STK290	Carbon steel pipe for scaffolding or structural purposes	-	-	-	0.05	0.05	290	-	25
STK400		0.25		-	-	0.04	0.04	400	235	18	
STK500		0.30		0.3-1.0	0.35	0.04	0.04	500	355	10	
STK540		0.23		1.5	0.55	0.04	0.04	540	390	10	
JIS G 3445 Mfg Standard	STKM11A	Carbon steel pipe for machine structural	0.12	0.60	0.35	0.04	0.04	290	-	30	
Conduit Pipe	BS 31 / BS 4568 Mfg Standard		Zinc coated steel pipe for electrical wiring	-	-	-	-	-	273-365	-	15
Earth Pipe	Mfg Standard		For civil works	0.20	1.20	-	0.045	0.045	270	170	20
Window Pipe	Mfg Standard		For housing window	0.20	1.20	-	0.045	0.045	270	170	20
Cement Lining Pipe	Mfg Standard		For carrying water	0.20	1.20	-	0.045	0.045	270	170	20
SuperDP Corrosion Resistance Pipe	BS 1387:1985	DP-P1	For general structural, water piping, agricultural, scaffolding, and etc	-	-	-	-	-	270		36
	JIS G 3445	DP-P2							270		39
	JIS G 3444	DP-34							340	245	20
	ASTM A500	DP-40							400	295	18
	BS 1139	DP-44							440	335	18
	Mfg Standard	DP-49							490	365	16
Sq & Rectangular Hollow Sections	ASTM A500/600 Mfg Standard	A	Steel hollows for general and machine structure.	0.3	-	-	0.05	0.63	310	269	25
		B		0.3	-	-	0.05	0.63	400	317	23
Sq & Rectangular Hollow Sections	Non-ASTM Mfg Standard	-	Steel hollows for general and machine structure.	0.3	-	-	0.05	0.63	310	269	25
				0.3	-	-	0.05	0.63	400	317	23
Hi-Ten GI Purlins	ASTM A446-D Mfg Standard	C-Purlin Z-Purlin	For roofing & cladding structure purpose	-	-	-	-	-	450	345	17
MS Angle Sections	AS/NZS 4600	Equal Unequal	Cold-rolled angle sections for ordinary usage	-	-	-	-	-	-	350-400 400-450	
MS Lipped-Channels	JIS G 3350 Mfg Standard	SS400	For roofing, cladding and general structural purpose	0.25	-	-	0.05	0.05	400	245	21
MS Plain-Channels	JIS G 3350 Mfg Standard	SS400	For general structural purposes	0.25	-	-	0.05	0.05	400	245	21
Decorative Hollow Sections	Mfg Standard	-	Cold-rolled wrought, oval hexagon, string sections	0.3	-	-	0.05	0.63	310	269	25
Other Cold-Rolled Sections	Mfg Standard	-	Monorials, channels, wrought angles and etc	0.3	-	-	0.05	0.63	310	269	25
Metal Roofing Sheet	Mfg Standard	-	Roofing and Cladding	-	-	-	-	-	-	-	-

*Standard and sizes that not specified may be produced upon special request.



British Standard Welded Steel Pipes

Technical Specification - BS 1387:1985

Our British Standard Steel Tubes are produced to BS 1387:1985 on our precision electric-resistance-weld-tube mills, using high quality steel.

GENERAL INFORMATION OF BS 1387:1985 WELDED STEEL TUBE

Descriptions:	Japmas Steel BS 1387:1985 welded steel tube is produced in three thickness classes-Light, Medium and Heavy - and is available in black or hot dipped galvanised finish in 6 meter uniform mill lengths.
Applications:	For ordinary conveyance of steam, gas, air, water, etc.
End Finish & End Protections:	Plain-end square-cut (PE) or threaded and fixed with coupling (T/C). PE tubes are shipped without any protection on both ends. T/C tubes are supplied screwed with taper threads to BS 21 and fitted with one taper-threaded malleable iron socket, as required under this specification.
Identification Marks:	According to Japmas Steel marking standard

IMPORTANT EXCERPTS FROM BS 1387:1985 SPECIFICATION

Chemical Composition:	The chemical composition of the steel, by ladle analysis, shall comply with the table below: <table border="1"> <tr> <td>C max.</td> <td>Mn max.</td> <td>P max.</td> <td>S max.</td> </tr> <tr> <td>0.20%</td> <td>1.20%</td> <td>0.045%</td> <td>0.045%</td> </tr> </table>	C max.	Mn max.	P max.	S max.	0.20%	1.20%	0.045%	0.045%
C max.	Mn max.	P max.	S max.						
0.20%	1.20%	0.045%	0.045%						
Mechanical Properties:	The mechanical properties at room temperature shall be given in the table below: Tensile strength (N/mm ²) 320 to 460 Yield strength (N/mm ²) 195 min Elongation on gauge length $L_0 = 5.65\sqrt{S_0(\%)}$ 20 min								
Tolerances on Dimensions and Mass:	Outside Diameter: As shown in tables on following pages Wall thickness: Light tubes - 8% Medium and heavy tubes - 10% Length: Plus 50mm or minus zero. Mass: The mean consignment mass for quantities of 150mm and cover of one size shall not deviate by more than $\pm 4\%$ from the mass of consignment calculated from the mass given in Table as appropriate. No single tube shall deviate by more than + 10%, -8% from the mass given in Table as appropriate.								
Bend Test:	Black tubes up to and including DN 50 shall be bent cold without any signs of fracture or failure, through 180 degrees round a former having a radius at the bottom of the groove equal to six times the outside diameter of the tubes as given in Table.								
Flattening Test:	The flattening test applies to tubes greater than DN 50. A ring not less than 40mm in length taken from one end of each selected tube shall be flattened cold between parallel flat platens without showing either crack or flaw until the distance between the platens, measured under load, is not greater than 75% of the original outside diameter of the tube, and no cracks or flaws in the metal elsewhere than in the weld shall occur until the distance between the platens is less than 60% of the original outside diameter. The weld shall be placed at 90 degrees to the direction of flattening.								
Leak Tightness test:	The test shall be either a hydraulic test at a pressure of 50 bar (700psi), or, alternatively an eddy current test								
Hot dip zinc coating test(on request)	After four successive one minute immersions in the copper sulphate, the test sample shall not show any adherent deposits of metallic copper.								
Bore test for hot dip galvanised tubes	Hot dip galvanised tubes up to and including DN 25 shall have a rod of 230mm in length, of the appropriate diameter below, passed through them and shall have a free bore. <table border="1"> <tr> <td>Nominal Size (DN)</td> <td>Rod diameter (mm)</td> </tr> <tr> <td>15</td> <td>9.5</td> </tr> <tr> <td>20</td> <td>14.3</td> </tr> <tr> <td>25</td> <td>20.6</td> </tr> </table>	Nominal Size (DN)	Rod diameter (mm)	15	9.5	20	14.3	25	20.6
Nominal Size (DN)	Rod diameter (mm)								
15	9.5								
20	14.3								
25	20.6								

British Standard Welded Steel Pipes



07

BS 1387:1985 (Light, Medium, Heavy) / Manufacturer's Standard

Thickness Class	Nominal size		Outside diameter		max.	min.	Wall Thickness mm	Calculated weight Plain End		
			max.	min.				kg/m	kg/ft	lb/ft
	mm	in	in	in	mm	mm				
Light Class A	15	1/2	0.843	0.827	21.4	21.0	2.0	0.947	0.289	0.636
	20	3/4	1.059	1.041	26.9	26.4	2.3	1.38	0.421	0.927
	25	1	1.331	1.307	33.8	33.2	2.6	1.98	0.604	1.33
	32	1 1/4	1.670	1.650	42.5	41.9	2.6	2.54	0.774	1.71
	40	1 1/2	1.903	1.882	48.4	47.8	2.9	3.23	0.985	2.17
	50	2	2.370	2.347	60.2	59.6	2.9	4.08	1.24	2.74
	65	2 1/2	2.991	2.960	76.0	75.2	3.2	5.71	1.74	3.84
	80	3	3.491	3.460	88.7	87.9	3.2	6.72	2.05	4.52
	100	4	4.481	4.450	113.9	113.0	3.6	9.75	2.97	6.55
Medium Class B	15	1/2	0.854	0.831	21.7	21.1	2.6	1.21	0.048	0.813
	20	3/4	1.072	1.047	27.2	26.6	2.6	1.56	0.476	1.05
	25	1	1.346	1.316	34.2	33.4	3.2	2.41	0.735	1.62
	32	1 1/4	1.687	1.657	42.9	42.1	3.2	3.10	0.945	2.08
	40	1 1/2	1.919	1.889	48.8	48.0	3.2	3.57	1.09	2.40
	50	2	2.394	2.354	60.8	59.8	3.6	5.03	1.53	3.38
	65	2 1/2	3.014	2.969	76.6	75.4	3.6	6.43	1.96	4.32
	80	3	3.524	3.469	89.5	88.1	4.0	8.37	2.58	5.69
	100	4	4.524	4.459	114.9	113.3	4.5	12.2	3.72	8.20
	150	6	6.539	6.459	166.1	164.1	5.0	19.70	6.01	13.20
Heavy Class C	15	1/2	0.854	0.831	21.7	21.1	3.2	1.44	0.439	0.968
	20	3/4	1.072	1.047	27.2	26.6	3.2	1.87	0.570	1.26
	25	1	1.346	1.316	34.2	33.4	4.0	2.94	0.896	1.98
	32	1 1/4	1.687	1.657	42.9	42.1	4.0	3.80	1.16	2.55
	40	1 1/2	1.919	1.889	48.8	48.0	4.0	4.38	1.34	2.94
	50	2	2.394	2.354	60.8	59.8	4.5	6.19	1.89	4.16
	65	2 1/2	3.014	2.969	76.6	75.4	4.5	7.93	2.42	5.33
	80	3	3.524	3.469	89.5	88.1	5.0	10.30	3.20	7.06
	100	4	4.524	4.459	114.9	113.3	5.4	14.50	4.42	9.74
	150	6	6.539	6.459	166.1	164.1	5.4	21.30	6.49	14.30

Tolerance for Wall Thickness: Light Tubes=Up to -8%
Medium & Heavy Tubes=Up to -10%



Welded Steel Pipes

Class Extra Light (AA)

Welded Steel Pipes Class Extra Light (AA)

Nominal size		Outside diameter						Calculated weight Plain End		
mm	in	maximum		minimum		mm	in	kg/m	kg/ft	lb/ft
		max	in	max	in					
15	1/2	21.4	0.84	21.0	0.83	1.6	0.063	0.773	0.236	0.520
20	3/4	26.9	1.06	26.4	1.04	1.6	0.063	0.990	0.302	0.666
25	1	33.8	1.33	33.2	1.31	1.9	0.075	1.48	0.451	0.994
32	1 1/4	42.5	1.67	41.9	1.65	1.9	0.075	1.89	0.576	1.27
40	1 1/2	48.4	1.90	47.8	1.88	1.9	0.075	2.16	0.658	1.45
50	2	60.2	2.30	59.6	2.35	1.9	0.075	2.75	0.829	1.83
65	2 1/2	76.0	2.99	75.2	2.96	1.9	0.075	3.45	1.05	2.31
80	3	88.7	3.49	87.9	3.46	2.1	0.083	4.46	1.36	3.00
90	3 1/2	102.0	3.98	101.1	3.95	2.1	0.083	5.15	1.57	3.46
100	4	113.9	4.48	113.0	4.45	2.3	0.091	6.31	1.92	4.23
125	5	140.6	5.53	138.7	5.46	4.0	0.157	13.4	4.08	8.99
150	6	166.1	6.54	164.1	6.46	4.0	0.157	15.9	4.85	10.7

Tolerance for Wall Thickness: ±10%

Cement Lining Pipes

Manufacturer's Standard

Outside Diameter	Minimum Nominal Wall Thickness	Outside Diameter		Calculated Weight Plain Ends
		Maximum	Minimum	
mm	mm	mm	mm	kg/m
121.9	4.1	123.2	120.7	13.22
177.3	3.7	179.1	175.5	17.51
	4.1	179.1	175.5	19.22
232.2	4.1	234.5	229.9	25.32

Carbon Steel Pipes

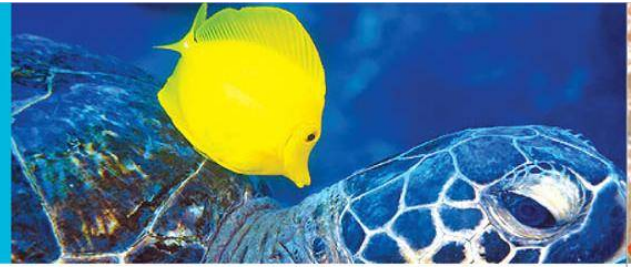

09

Carbon Steel Pipes for Ordinary Piping (BS EN 1029 Part 2-1997)

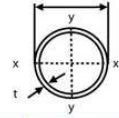

Designation		Mass Per Metre	Area Of Section	Ratio For Local Buckling	Second Moment Of Inertia	Radius Of Gyration	Elastic Modulus	Plastic Modulus	Torsional Constants		Surface Area Per Metre
Outside	Thickness								J	C	
D	t	A	D/t	I	r	Z	S	J	C	m ² /m	
mm	mm	kg/m	cm ²	cm ⁴	cm	cm ³	cm ³	cm ⁴	cm ³	m ² /m	
114.3	3.0	8.23	10.5	38.1	163	3.94	28.4	37.2	325	56.9	0.359
	3.2	8.77	11.2	35.7	172	3.93	30.2	39.5	345	60.4	0.359
	5.0	13.48	17.2	22.9	257	3.87	45.0	59.8	514	89.9	0.359
	6.0	16.03	20.4	19.1	300	3.83	52.5	70.4	600	105	0.359
	6.3	16.78	21.4	18.1	313	3.82	54.7	73.6	625	109	0.359
139.7	6.3	20.73	26.4	22.2	589	4.72	84.3	112	1177	169	0.439
	8.0	25.98	33.1	17.5	720	4.66	103	139	1441	206	0.439
	10.0	31.99	40.7	14.0	862	4.60	123	169	1724	247	0.439
168.3	4.0	16.21	20.6	42.1	697	5.81	82.8	108	1394	166	0.529
	6.3	25.17	32.1	26.7	1053	5.73	125	165	2107	250	0.529
	8.0	31.63	40.3	21.0	1297	5.67	154	206	2595	308	0.529
	10.0	39.04	49.7	16.8	1564	5.61	186	251	3128	372	0.529
	12.5	48.03	61.2	13.5	1868	5.53	222	304	3737	444	0.529
193.7	4.0	18.71	23.8	48.4	1073	6.71	111	144	2146	222	0.609
	4.5	21.00	26.7	43.0	1198	6.69	124	161	2395	247	0.609
	5.0	23.27	29.6	38.7	1320	6.67	136	178	2640	273	0.609
	6.0	27.77	35.4	32.3	1560	6.64	161	211	3119	322	0.609
	6.3	29.12	37.1	30.7	1630	6.63	168	221	3260	337	0.609
	8.0	36.64	46.7	24.2	2016	6.57	208	276	4031	416	0.609
	10.0	45.30	57.7	19.4	2442	6.50	252	338	4883	504	0.609
	12.5	55.86	71.2	15.5	2934	6.42	303	411	5869	605	0.609
219.1	4.5	23.82	30.3	48.7	1747	7.59	159	207	3494	319	0.688
	5.0	26.40	33.6	43.8	1928	7.57	176	229	3856	352	0.688
	6.0	31.53	40.2	36.5	2282	7.54	208	273	4564	417	0.688
	6.3	33.06	42.1	34.8	2386	7.53	218	285	4772	436	0.688
	8.0	41.65	53.1	27.4	2960	7.47	270	357	5919	540	0.688
	10.0	51.57	65.7	21.9	3598	7.40	328	438	7197	657	0.688
	12.0	61.29	78.1	18.3	4200	7.33	383	515	8400	767	0.688
	12.5	63.69	81.1	17.5	4345	7.32	397	534	8689	793	0.688
	16.0	80.14	102	13.7	5297	7.20	483	661	10600	967	0.688
244.5	5.0	29.53	37.6	48.9	2699	8.47	221	287	5397	441	0.768
	6.0	35.29	45.0	40.8	3199	8.43	262	341	6397	523	0.768
	6.3	37.01	47.1	38.8	3346	8.42	274	358	6692	547	0.768
	8.0	46.66	59.4	30.6	4160	8.37	340	448	8321	681	0.768
	10.0	57.83	73.7	24.5	5173	8.30	415	550	10150	830	0.768
	12.0	68.81	87.7	20.4	5938	8.23	486	649	11880	972	0.768
	12.5	71.52	91.1	19.6	6147	8.21	503	673	12300	1006	0.768
	16.0	90.15	115	15.3	7533	8.10	616	837	15070	1232	0.768
273	5.0	33.05	42.1	54.6	3781	9.48	277	359	7562	554	0.858
	6.0	39.51	50.3	45.5	4487	9.44	329	428	8974	657	0.858
	6.3	41.44	52.8	43.3	4696	9.43	344	448	9392	688	0.858
	8.0	52.28	66.6	34.1	5852	9.37	429	562	11700	857	0.858
	10.0	64.86	82.6	27.3	7154	9.31	524	692	14310	1048	0.858
	12.0	77.24	98.4	22.8	8396	9.24	615	818	16790	1230	0.858
	12.5	80.30	102	21.8	8697	9.22	637	849	17400	1274	0.858
	16.0	101.41	129	17.1	10710	9.10	784	1058	21410	1569	0.858
323.9	5.0	39.32	50.1	64.8	6369	11.3	393	509	12740	787	1.02
	6.0	47.04	59.9	54.0	7572	11.2	468	606	15150	935	1.02
	6.3	49.34	62.9	51.4	7929	11.2	490	636	15860	979	1.02
	8.0	62.32	79.4	40.5	9910	11.2	612	799	19820	1224	1.02
	10.0	77.41	98.6	32.4	12160	11.1	751	986	24320	1501	1.02
	12.0	92.30	118	27.0	14320	11.0	884	1168	28640	1768	1.02
	12.5	95.99	122	25.9	14850	11.0	917	1213	29690	1833	1.02
	16.0	121.49	155	20.2	18390	10.9	1136	1518	36780	2271	1.02

* Sizes not included in BS EN 10219 Part 2 (1997)

Earth/Window/ Scaffolding Pipes

Earth Pipes

NOMINAL	SIZE	OUTSIDE DIAMETER	WALL THICKNESS	WEIGHT			
mm 50	in 2	mm 60.33	mm 1.60	kg/m 2.317	kg/4.877m 11.313	kg/ft 0.707	lb/ft 1.558

Window Pipes

NOMINAL	SIZE	OUTSIDE DIAMETER	WALL THICKNESS	WEIGHT			
mm 15	in 0.625	mm 15.9	mm 1.00	kg/m 0.2979	kg/4.877m 0.787	kg/ft 0.0908	lb/ft 0.2002
15	0.625	15.9	1.20	0.435	2.610	0.133	0.293

Scaffolding Pipes (BS 1139: Section 1.1:1990)

Outside Diameter	Wall Thickness	Calculated Weight	Cross-Sectional Sectional Area	Second Moment of Inertia	Section of Modulus	Radius of Gyration of Area	Plastic Modulus
mm	mm	kg/m	cm ²	cm ⁴	cm ³	cm	cm ³
48.3	4.0	4.37	5.57	13.8	5.70	1.57	7.87

Tolerances: Thickness $\pm 10\%$
Outside Diameter $\pm 0.5\text{mm}$

Scaffolding Pipes (JIS G 3444/88 / Manufacturer's Standard)

Nominal Size	Standard Specification	Outside Diameter		Wall Thickness	Weight	Reference			
		Min	Max			Cross Sectional Area	Grometrical Moment of Inertia	Modulus of Section	Radius of Gyration of Area
mm		mm	mm	mm	kg/m	cm ²	cm ⁴	cm ³	cm
21.7 O/D	STK 290	21.45	21.95	1.2	0.607	0.773	0.407	0.375	0.726
				1.5	0.747	0.952	0.488	0.450	0.716
				1.6	0.793	1.010	0.513	0.473	0.713
				2.0	0.972	1.238	0.607	0.560	0.700
42.7 OD	STK 500	42.45	42.95	2.3	2.290	2.919	5.97	2.80	1.43
				2.5	2.490	3.157	6.40	3.00	1.42
				2.8	2.760	3.510	7.02	3.29	1.41
48.6 OD	STK 500	48.35	48.85	2.3	2.63	3.345	8.99	3.70	1.64
				2.5	2.84	3.621	9.65	3.97	1.63
				2.8	3.16	4.029	10.6	4.36	1.62
				3.2	3.58	4.564	11.8	4.86	1.61

- 1) When Wall Thickness < 3.0mm, tolerance = $\pm 0.3\text{mm}$
2) When 3.0mm \leq wall thickness < 12mm, tolerance = $\pm 10\%$

Production for different sizes and the thicknesses are also available upon request

Carbon Steel Tubes for Machine Structural



JIS G 3445:1988 STKM 11 A / Manufacturer's Standard

NOMINAL SIZE	OUTER DIAMETER		THICKNESS								
			19				18				
			1.0				1.2				
			0.039				0.047				
mm	in	mm	kg/m	kg/6m	kg/ft	lb/ft	kg/m	kg/6m	kg/ft	lb/ft	
10	3/8	9.5	0.210	1.26	0.0639	0.141					
12	1/2	12.7	0.289	1.734	0.088	0.194	0.340	2.040	0.104	0.229	
16	5/8	15.9	0.368	2.208	0.112	0.247	0.435	2.610	0.133	0.293	
19	3/4	19.1	0.447	2.682	0.136	0.300	0.530	3.180	0.162	0.357	
22	7/8	22.2	0.523	3.138	0.159	0.351	0.622	3.732	0.189	0.417	
25	1	25.4	0.602	3.612	0.183	0.404	0.716	4.296	0.218	0.481	
28	1 1/8	28.6	0.681	4.086	0.208	0.459	0.811	4.886	0.247	0.545	
32	1 1/4	31.8	0.760	4.560	0.232	0.512	0.906	5.436	0.276	0.609	
35	1 3/8	34.9					1000	6.000	0.304	0.670	
38	1 1/2	38.1					1.092	6.552	0.333	0.734	
41	1 5/8	41.3					1.187	7.122	0.362	0.798	
44	1 3/4	44.5					1.281	7.686	0.391	0.862	
47	1 7/8	47.6					1.373	8.238	0.419	0.924	
50	2	50.8					1.468	8.808	0.447	0.986	
54	2 1/8	54.0					1.563	9.378	0.476	1.049	
57	2 1/4	57.2									
60	2 3/8	60.3									
65	2 1/2	63.5									

NOMINAL SIZE	OUTER DIAMETER		THICKNESS							
			1.6				14			
			1.6				2.0			
			0.063				0.079			
mm	in	mm	kg/m	kg/6m	kg/ft	lb/ft	kg/m	kg/6m	kg/ft	lb/ft
12	1/2	12.7	0.438	2.628	0.134	0.296	0.528	3.168	0.161	0.355
16	5/8	15.9	0.564	3.384	0.172	0.379	0.686	4.116	0.209	0.461
19	3/4	19.1	0.691	4.146	0.211	0.465	0.844	5.064	0.257	0.567
22	7/8	22.2	0.813	4.878	0.248	0.547	0.996	5.976	0.304	0.670
25	1	25.4	0.939	5.634	0.286	0.631	1.154	6.924	0.352	0.776
28	1 1/8	28.6	1.066	6.396	0.325	0.717	1.312	7.872	0.400	0.882
32	1 1/4	31.8	1.192	7.152	0.363	0.800	1.470	8.820	0.448	0.988
35	1 3/8	34.9	1.318	7.908	0.402	0.886	1.623	9.738	0.495	1.091
38	1 1/2	38.1	1.440	8.640	0.439	0.968	1.781	10.686	0.543	1.197
41	1 5/8	41.3	1.567	9.402	0.478	1.054	1.938	11.628	0.591	1.303
44	1 3/4	44.5	1.693	10.158	0.516	1.138	2.096	12.576	0.639	1.409
47	1 7/8	47.6	1.815	10.890	0.553	1.219	2.249	13.494	0.686	1.512
50	2	50.8	1.942	11.652	0.592	1.305	2.407	14.442	0.734	1.618
54	2 1/8	54.0	2.068	12.408	0.630	1.389	2.565	15.390	0.782	1.724
57	2 1/4	57.2	2.194	13.164	0.669	1.475	2.723	16.338	0.830	1.830
60	2 3/8	60.3	2.316	13.896	0.706	1.557	2.876	17.256	0.877	1.934
65	2 1/2	63.5	2.443	14.658	0.745	1.642	3.033	18.198	0.925	2.039

Production for different sizes and the thicknesses are also available upon request



Galvanized Steel

Electrical Conduit Tubes

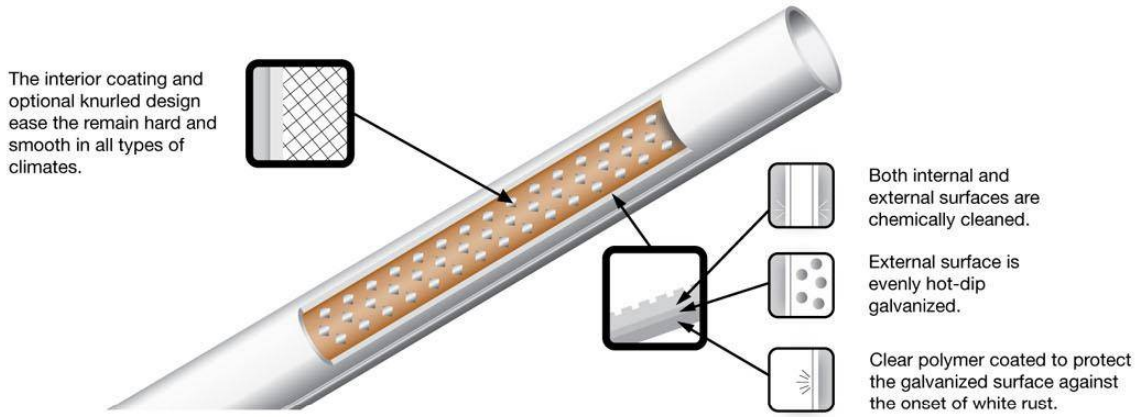

Galvanized Steel Electrical Conduits

Nominal Size		Outer Diameter				Wall Thickness				Calculated Weight With Coupler			Number Threads	Length of Threads			
		Maximum		Minimum		Nominal		Maximum						Maximum		Minimum	
mm	in	mm	in	mm	in	mm	in	mm	in	kg/m	kg/ft	lb/ft	Per Inch	mm	in	mm	in
19	3/4	19.05	0.750	18.76	0.7387	1.63	0.064	1.52	0.060	0.731	0.217	0.479	16	14.3	0.5625	12.7	0.5000
23	1	25.40	1.000	25.11	0.9887	1.63	0.064	1.52	0.060	0.972	0.296	0.653	16	17.5	0.6875	15.9	0.6250
32	1 1/4	31.75	1.250	31.46	1.2387	1.63	0.064	1.52	0.060	1.240	0.376	0.830	16	19.1	0.7500	17.5	0.6875
38	1 1/2	38.10	1.500	37.80	1.4880	1.83	0.072	1.73	0.068	1.680	0.511	1.130	14	20.6	0.8125	19.1	0.7500
50	2	50.80	2.000	50.50	1.9880	2.03	0.080	1.93	0.076	2.510	0.765	1.690	14	23.8	0.9375	22.2	0.8750

Standard Length 3.810 m (12ft. 6 in.) without coupler

Features

- Made of hot-dip galvanized steel strip with extra-smooth surface and highly-adherent zinc coating by the unique tube-making process. The weld zone coating restored in line.
- Inside weld bead controlled to a minimum for easier wire pulling.
- Screwed on both ends to BS 31 and fitted with a zinc-coated coupler on one end.
- Packed in bare bundles but the unsocketed ends protected with plastic caps.
- Easier to cut thread, bend, pull. Dimensionally accurate. Uniform quality in every respect.

Supply Condition:

- Length:
Standard length is 12 1/2ft (3.810) without coupler
Cut-to-length is available upon request

Mechanical Properties:

- Tensile Strength: 273 - 365 N/mm2
- Elongation: 15% (min)

Tolerance:

-0mm, +30mm

Cost Saving:

- The colour coated steel eliminates the need to paint when installing.



SuperDP[®]

Corrosion Resistance Pipes



SuperDP[®] pipe is produced by the latest pre-coated-alloy steel material (Zn-11%A-3%Mg-0.2%Si) with capacity to protect against corrosion enhanced by adding silicon and magnesium. The corrosion resistance which assessed by salt-spray tests is approximately 30 times that of conventional Zn-coated pipes.

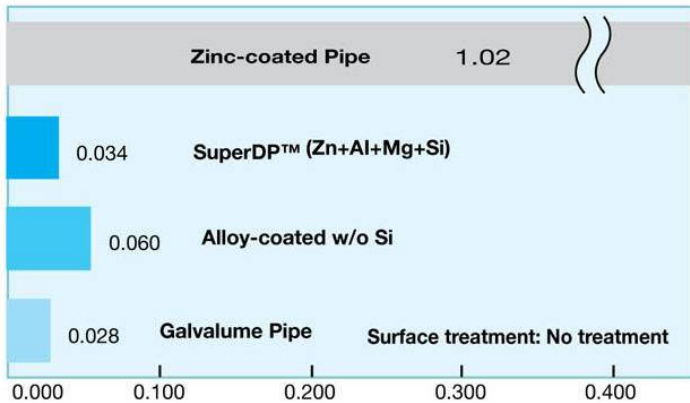

SuperDP[®] gives the best protection around the cut-end surface. The composition of the coating around the cut-end surface is such that it leeches out to form a tight protective film. This tight film covers the cut-end surface within several months.

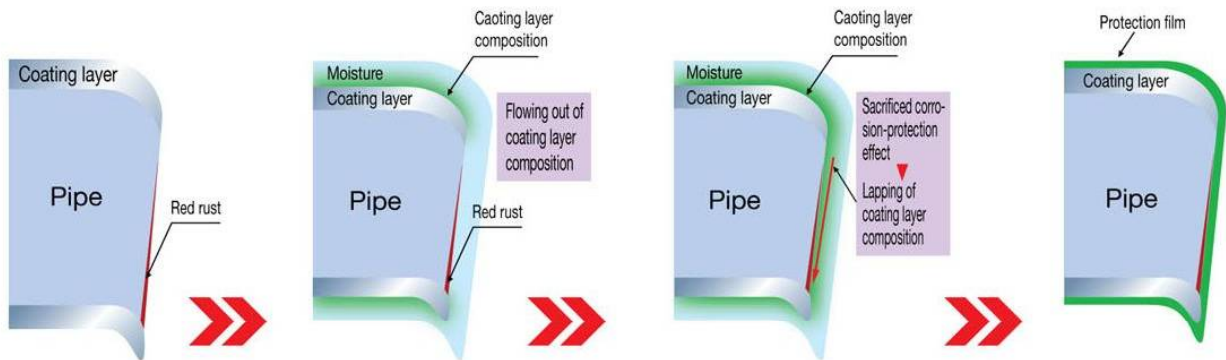

Yield Point, Tensile Strength and Elongation of SuperDP[®] Series

Series	Yield Point (N/mm ²)	Tensile Strength (N/mm ²)	Elongation (Normal Thk BS1387)			
			AA	A	B	C
SuperDP [®] -P1	-	270≤	34≤	35≤	35≤	36≤
SuperDP [®] -P2	-	270≤	-	38≤	38≤	39≤
SuperDP [®] -34	245≤	340≤	20≤	20≤	20≤	20≤
SuperDP [®] -40	295≤	400≤	18≤	18≤	18≤	18≤
SuperDP [®] -44	335≤	440≤	18≤	18≤	18≤	18≤
SuperDP [®] -49	365≤	490≤	16≤	16≤	16≤	16≤

Available Size Ø: 1/2", 3/4", 1", 1 1/4", 1 1/2", 2", 2 1/2", 3", 3 1/2", 4", 5", 6", 7" and 8"



Square & Rectangular Sections

Technical Specification

TECHNICAL SPECIFICATION of ASTM A-500 / A-600 (Grade A and B / Manufacturer Standard)

Tolerances in Outside Dimensions	Largest Outside Dimension, across flats. in (mm)	Tolerances, plus and minus, in (mm)				
	2 1/2 (63.5) and under	0.020 (0.51)				
	Over 2 1/2 to 3 1/2 (63.5 to 88.9), incl.	0.025 (0.64)				
	Over 3 1/2 to 5 1/2 (88.9 to 139.7), incl.	0.030 (0.76)				
	Over 5 1/2 (139.7). (Tolerances include allowance for convexity or concavity)	1%				
Tolerances in Wall Thickness	Plus and minus 10% of nominal thickness, exclusive of weld area					
Tolerances in Straightness	1/8 in. x $\frac{\text{Total Length in ft}}{5}$					
Squareness of Sides	Adjacent sides may deviate from 90 degrees by plus and minus 2 degrees max.					
Tolerances in Twist	Specified Dimension of Longest Side in (mm)	Maximum Twist in 3 ft. in.	Maximum Twist in 1m. in.			
	1 1/2 (38.1) and under	0.050	1.39			
	Over 1 1/2 to 2 1/2 (38.1 to 63.5), incl.	0.062	1.72			
	Over 2 1/2 to 4 (63.5 to 101.6), incl.	0.075	2.09			
	Over 4 to 6 (101.6 to 152.4), incl.	0.087	2.42			
	Over 6 to 8 (152.4 to 203.2), incl.	0.100	2.78			
	Over 8 (203.2)	0.112	3.11			
Chemical Composition (Heat Analysis)	ASTM A-500 Specification					
		Grade A	Grade B	Grade C	Grade D	
	Carbon, max, %	0.26	0.26	0.23	0.26	
	Manganese, max, %	-	-	1.35	-	
	Phosphorus, max., %	0.04	0.04	0.04	0.04	
Sulphur, max., %	0.05	0.05	0.05	0.05		
Mechanical Properties	ASTM A-500 Specification					
		Grade A	Grade B	Grade C	Grade D	Manufacturer. Standard
	Tensile strength, min, psi (MPa)	45,000 (310)	58,000 (400)	62,000 (427)	58,000 (400)	270 N/mm ² min
	Yield point, min., psi (MPa)	39,000 (269)	46,000 (317)	50,000 (345)	36,000 (250)	170 N/mm ² min
	Elongation (Gauge length 2")	As specified in A-500 specification				20%min.

Square Hollow Sections

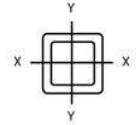

ASTM A 500 Grades A And B/Manufacturer's Standard

SIZE		DIMENSIONS							MOMENT OF INERTIA		SECTION MODULUS		RADIUS OF GYRATION		PLASTIC MODULUS	
NOMINAL	ACTUAL	WALL THICKNESS		CALCULATED WEIGHT				AREA	I _x	I _y	Z _x	Z _y	i _x	i _y	S _x	S _y
mm	in	mm	in	kg/m	kg/6m	kg/ft	lb/ft	in ²	in ⁴	in ⁴	in ³	in ³	in	in	in ³	in ³
12 x 12	1/2 x 1/2	1.0	0.039	0.357	2.142	0.109	0.240	0.0706	0.00249	0.00249	0.00996	0.00996	0.188	0.188	0.0121	0.0121
		1.2	0.047	0.421	2.526	0.128	0.283	0.0833	0.00284	0.00284	0.0113	0.0113	0.185	0.185	0.0141	0.0141
		1.6	0.063	0.540	3.240	0.165	0.363	0.107	0.00339	0.00339	0.0136	0.0136	0.178	0.178	0.0174	0.0174
16 x 16	5/8 x 5/8	1.0	0.039	0.456	2.736	0.139	0.306	0.0901	0.00513	0.00513	0.0164	0.0164	0.239	0.239	0.0197	0.0197
		1.2	0.047	0.540	3.249	0.165	0.636	0.107	0.00592	0.00592	0.0189	0.0189	0.235	0.235	0.0230	0.0230
		1.6	0.063	0.699	4.194	0.213	0.470	0.138	0.00724	0.00724	0.0232	0.0232	0.229	0.229	0.0290	0.0290
19 x 19	3/4 x 3/4	1.0	0.039	0.555	3.330	0.169	0.373	0.110	0.00920	0.00920	0.0245	0.0245	0.290	0.290	0.0291	0.0291
		1.2	0.047	0.659	3.954	0.201	0.443	0.130	0.0107	0.0107	0.0285	0.0285	0.286	0.286	0.0342	0.0342
		1.6	0.063	0.859	5.154	0.262	0.577	0.170	0.0133	0.0133	0.0354	0.0354	0.280	0.280	0.0435	0.0435
25 x 25	1 x 1	1.0	0.039	0.752	4.512	0.229	0.505	0.149	0.0228	0.0228	0.0456	0.0456	0.392	0.392	0.0534	0.0534
		1.2	0.047	0.897	5.382	0.273	0.603	0.177	0.0267	0.0267	0.0535	0.0535	0.388	0.388	0.0632	0.0632
		1.6	0.063	1.18	7.080	0.359	0.791	0.233	0.0339	0.0339	0.0678	0.0678	0.382	0.382	0.0814	0.0814
		2.3	0.091	1.54	9.240	0.470	1.05	0.331	0.0443	0.0443	0.089	0.089	0.371	0.371	0.1086	0.1086
		3.0	0.120	2.07	12.420	0.632	1.39	0.410	0.0528	0.0528	0.106	0.106	0.359	0.359	0.134	0.134
		3.2	0.125	2.15	12.900	0.654	1.44	0.424	0.0540	0.0540	0.108	0.108	0.357	0.357	0.138	0.138
32 x 32	1 1/4 x 1 1/4	1.2	0.047	1.13	6.780	0.346	0.762	0.224	0.0539	0.0539	0.0863	0.0863	0.490	0.490	0.101	0.101
		1.6	0.063	1.50	9.000	0.456	1.01	0.296	0.0692	0.0692	0.111	0.111	0.484	0.484	0.131	0.131
		2.3	0.091	2.02	12.120	0.616	1.36	0.414	0.0922	0.0922	0.148	0.148	0.472	0.472	0.179	0.179
		3.0	0.120	2.68	16.080	0.817	1.80	0.530	0.112	0.112	0.180	0.180	0.460	0.460	0.223	0.223
		3.2	0.125	2.78	16.680	0.847	1.87	0.549	0.115	0.115	0.185	0.185	0.458	0.458	0.230	0.230
38 x 38	1 1/2 x 1 1/2	1.2	0.047	1.37	8.220	0.418	0.922	0.271	0.0952	0.0952	0.127	0.127	0.592	0.592	0.147	0.147
		1.6	0.063	1.81	10.860	0.553	1.22	0.359	0.123	0.123	0.164	0.164	0.586	0.586	0.193	0.193
		2.3	0.091	2.48	14.880	0.756	1.67	0.505	0.166	0.166	0.221	0.221	0.573	0.573	0.256	0.256
		3.0	0.120	3.29	19.740	1.000	2.21	0.650	0.205	0.205	0.274	0.274	0.562	0.562	0.335	0.335
		3.2	0.125	3.41	20.460	1.040	2.29	0.674	0.211	0.211	0.282	0.282	0.560	0.560	0.346	0.346



Square Hollow Sections

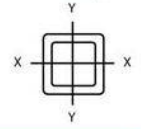

ASTM A 500 Grades A And B/Manufacturer's Standard

SIZE		DIMENSIONS						MOMENT OF INERTIA		SECTION MODULUS		RADIUS OF GYRATION		PLASTIC MODULUS		
		WALL THICKNESS		CALCULATED WEIGHT				AREA	I _x	I _y	Z _x	Z _y	i _x	i _y	S _x	S _y
NOMINAL	ACTUAL	mm	in	kg/m	kg/6m	kg/ft	lb/ft	in ²	in ⁴	in ⁴	in ³	in ³	in	in	in ³	in ³
50 x 50	2 x 2	1.6	0.063	2.45	14.700	0.747	1.65	0.485	0.302	0.302	0.302	0.302	0.790	0.790	0.351	0.351
		2.3	0.091	3.40	20.400	1.04	2.28	0.689	0.416	0.416	0.416	0.416	0.777	0.777	0.494	0.494
		3.0	0.120	4.38	26.280	1.33	2.94	0.865	0.498	0.498	0.498	0.498	0.759	0.759	0.601	0.601
		3.2	0.125	4.54	27.240	1.38	3.05	0.897	0.513	0.513	0.513	0.513	0.756	0.756	0.621	0.621
		4.0	0.156	5.50	33.000	1.68	3.70	1.09	0.598	0.598	0.598	0.598	0.741	0.741	0.737	0.737
		4.5	0.177	6.11	36.654	1.86	4.10	1.21	0.644	0.644	0.644	0.644	0.730	0.730	0.807	0.807
65 x 65	2 1/2 x 2 1/2	2.3	0.091	4.31	25.878	1.32	2.90	0.86	0.82	0.82	0.656	0.656	0.976	0.976	0.861	0.861
		3.0	0.120	5.59	33.540	1.70	3.76	1.11	1.03	1.03	0.820	0.820	0.963	0.963	0.975	0.975
		3.2	0.125	5.80	34.800	1.77	3.90	1.15	1.06	1.06	0.847	0.847	0.961	0.961	1.01	1.01
		4.0	0.156	7.08	47.480	2.16	4.76	1.40	1.25	1.25	1.00	1.00	0.946	0.946	1.21	1.21
		4.5	0.177	7.88	47.271	2.40	5.30	1.56	1.36	1.36	1.09	1.09	0.935	0.935	1.31	1.31
		6.0	0.236	10.10	60.590	3.08	6.77	1.99	1.72	1.72	1.37	1.37	0.928	0.928	1.72	1.72
75 x 75	3 x 3	2.3	0.091	5.23	34.386	1.59	3.52	1.03	1.44	1.44	0.96	0.96	1.19	1.19	1.25	1.25
		3.0	0.120	6.81	40.860	2.07	4.57	1.35	1.83	1.83	1.22	1.22	1.17	1.17	1.44	1.44
		3.2	0.125	7.07	42.420	2.15	4.75	1.40	1.90	1.90	1.26	1.26	1.16	1.16	1.49	1.49
		4.0	0.156	8.66	51.960	2.64	5.82	1.71	2.26	2.26	1.51	1.51	1.15	1.15	1.80	1.80
		4.5	0.177	9.70	58.191	2.95	6.52	1.92	2.48	2.48	1.65	1.65	1.14	1.14	2.00	2.00
		5.0	0.197	10.76	64.555	3.26	7.21	2.13	2.72	2.72	1.81	1.81	1.13	1.13	2.18	2.18
90 x 90	3 1/2 x 3 1/2	3.0	0.120	8.02	48.120	2.44	5.39	1.59	2.98	2.98	1.70	1.70	1.37	1.37	1.99	1.99
		3.2	0.125	8.33	49.980	2.54	5.60	1.65	3.09	3.09	1.76	1.76	1.37	1.37	2.07	2.07
		4.0	0.156	10.20	61.200	3.12	6.88	2.02	3.71	3.71	2.12	2.12	1.35	1.35	2.51	2.51
		4.5	0.177	11.50	68.984	3.50	7.70	2.27	4.10	4.10	2.34	2.34	1.34	1.34	2.79	2.79
		5.0	0.197	12.76	76.582	3.88	8.55	2.52	4.51	4.51	2.58	2.58	1.34	1.34	3.06	3.06
		6.0	0.236	14.88	89.273	4.54	9.98	2.94	5.12	5.12	2.92	2.92	1.32	1.32	3.78	3.78

Square Hollow Sections

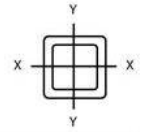

ASTM A 500 Grades A And B/Manufacturer's Standard

SIZE		DIMENSIONS						MOMENT OF INERTIA		SECTION MODULUS		RADIUS OF GYRATION		PLASTIC MODULUS		
		WALL THICKNESS		CALCULATED WEIGHT												AREA
NOMINAL	ACTUAL	mm in		kg/m	kg/6m	kg/ft	lb/ft	in ²	I _x	I _y	Z _x	Z _y	i _x	i _y	S _x	S _y
mm	in	mm	in	kg/m	kg/6m	kg/ft	lb/ft	in ²	in ⁴	in ⁴	in ³	in ³	in	in	in ³	in ³
100 x 100	4 x 4	3.0	0.120	9.23	55.38	2.81	6.21	1.83	4.53	4.53	2.27	2.27	1.58	1.58	2.64	2.64
		3.2	0.125	9.60	57.600	2.93	6.45	1.90	4.70	4.70	2.35	2.35	1.57	1.57	2.74	2.74
		4.0	0.156	11.8	70.800	3.60	7.94	2.34	5.67	5.67	2.84	2.84	1.56	1.56	3.34	3.34
		4.5	0.177	13.3	79.874	4.06	8.95	2.63	6.28	6.28	3.14	3.14	1.55	1.55	3.72	3.72
		5.0	0.197	14.7	88.295	4.48	9.89	2.91	6.89	6.89	3.44	3.44	1.54	1.54	4.04	4.04
		6.0	0.236	17.2	103.110	5.22	11.50	3.39	7.82	7.82	3.91	3.91	1.52	1.52	4.69	4.69
		9.0	0.354	24.1	144.5	7.34	16.1	4.75	9.80	9.80	5.19	5.19	1.44	1.44	6.44	6.44
125 x 125	5 x 5	4.5	0.177	16.9	101.400	5.15	11.4	3.33	12.7	12.7	5.08	5.08	1.97	1.97	5.96	5.96
		5.0	0.197	18.7	112.260	5.71	12.6	3.70	14.0	14.0	5.61	5.61	1.95	1.95	6.51	6.51
		6.0	0.236	22.1	132.420	6.73	14.8	4.34	16.0	16.0	6.42	6.42	1.92	1.92	7.63	7.63
		9.0	0.354	31.1	186.87	9.49	20.9	6.15	20.8	20.8	8.42	8.42	1.85	1.85	10.45	10.45
150 x 150	6 x 6	4.5	0.177	20.5	122.940	6.25	13.8	4.04	22.5	22.5	7.50	7.50	2.36	2.36	8.73	8.73
		5.0	0.197	22.7	135.970	6.90	15.21	4.48	24.9	24.9	8.30	8.30	2.36	2.36	9.58	9.58
		6.0	0.236	26.9	161.000	8.19	18.0	5.28	28.7	28.7	9.58	9.58	2.33	2.33	11.3	11.3
		9.0	0.354	38.2	229.26	11.64	25.6	7.54	38.0	38.0	12.8	12.8	2.24	2.24	15.4	15.4
175 x 175	7 x 7	4.5	0.177	23.7	142.1	7.22	15.9	4.68	33.3	33.3	9.66	9.66	2.67	2.67	11.7	11.7
		6.0	0.197	31.1	186.9	9.49	20.9	6.14	43.2	43.2	12.5	12.5	2.65	2.65	14.8	14.8
		9.0	0.236	45.3	271.6	13.8	30.4	8.94	61.5	61.5	17.9	17.9	2.62	2.62	21.4	21.4
		12.0	0.354	58.5	351.1	17.8	39.2	11.6	77.9	77.9	22.6	22.6	2.60	2.60	27.5	27.5
200 x 200	8 x 8	4.5	0.177	27.2	163.3	8.30	18.2	5.37	52.6	52.6	13.4	13.4	3.13	3.13	14.8	14.8
		6.0	0.197	35.8	214.9	10.9	24.0	7.07	68.0	68.0	17.3	17.3	3.10	3.10	20.1	20.1
		9.0	0.236	52.3	313.8	16.0	35.1	10.3	95.9	95.9	24.3	24.3	3.04	3.04	28.8	28.8
		12.0	0.354	67.9	407.6	20.7	45.6	13.4	119.6	119.6	30.4	30.4	2.99	2.99	36.7	36.7
250 x 250	10 x 10	6.0	0.197	45.2	271.5	13.8	30.3	8.93	136.2	136.2	27.7	27.7	3.91	3.91	37.0	37.0
		9.0	0.236	66.5	398.8	20.3	44.6	13.1	194.4	194.4	39.5	39.5	3.85	3.85	46.3	46.3
		12.0	0.354	86.8	520.6	26.4	58.2	17.1	247.5	247.5	50.0	50.0	3.79	3.79	59.5	59.5



Square Hollow Sections

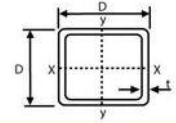

SHS - Size not included in EN 10219/ASTM A500

Designation Size	Thickness	Mass Per Metre	Area Of Section	Second Moment Of Area	Radius Of Gyration	Elastic Modulus	Plastic Modulus	Torsional Constants	Surface Area Per Metre	
DxD	t		A	I	r	Z	S	J	C	
mm	mm	kg/m	cm ²	cm ²	cm	cm ³	cm ³	cm ⁴	cm ⁴	m ² /m
13 x 13	1.2 *	0.400	0.529	0.118	0.473	0.182	0.228	0.205	0.278	0.0479
	1.6 *	0.500	0.664	0.136	0.453	0.209	0.273	0.247	0.324	0.0455
20 x 20	2.0	1.05	1.34	0.692	0.720	0.692	0.877	1.21	1.06	0.0731
	2.5 *	1.25	1.59	0.766	0.694	0.766	1.00	1.39	1.19	0.1714
30 x 30	1.2 *	1.08	1.35	1.83	1.17	1.22	1.44	2.93	1.84	0.116
	1.6 *	1.41	1.75	2.31	1.15	1.54	1.84	3.77	2.32	0.115
	1.8 *	1.57	1.95	2.52	1.14	1.68	2.03	4.16	2.54	0.114
	2.3 *	1.97	2.41	2.99	1.11	2.00	2.45	5.07	3.03	0.112
	3.0	2.48	3.01	3.50	1.08	2.34	2.96	6.15	3.58	0.110
	3.2 *	2.62	3.17	3.62	1.07	2.41	3.08	6.42	3.71	0.109
40 x 40	2.0	2.31	2.94	6.94	1.54	3.47	4.13	11.3	5.23	0.153
	2.5	2.82	3.59	8.22	1.51	4.11	4.97	13.6	6.21	0.151
	3.0	3.30	4.21	9.32	1.49	4.66	5.72	15.8	7.07	0.150
	4.0	4.20	5.35	11.1	1.44	5.54	7.01	19.4	8.48	0.146
45 x 45	4 *	5.01	6.39	17.6	1.66	7.82	9.71	28.7	11.3	0.170
	5 *	6.07	7.73	20.1	1.61	8.95	11.41	33.5	12.9	0.167
60 x 60	1.6 *	2.88	3.67	20.7	2.37	6.89	8.0	32.4	10.4	0.235
	2.3 *	4.06	5.17	28.3	2.34	9.44	11.1	45.2	14.2	0.232
	3.0	5.19	6.61	35.1	2.31	11.7	14.0	57.1	17.7	0.230
	3.2 *	5.50	7.01	36.9	2.30	12.3	14.7	60.3	18.6	0.229
	4.0	6.71	8.55	43.6	2.26	14.5	17.6	72.6	22.0	0.226
	4.5 *	7.43	9.47	47.2	2.23	15.7	19.3	79.8	23.9	0.225
63.5 x 63.5	6.0	9.44	12.0	56.1	2.16	18.7	23.7	98.4	28.5	0.219
	2.3 *	4.31	5.49	33.9	2.48	10.7	12.5	53.8	16.0	0.246
	3.0 *	5.52	7.03	42.1	2.45	13.3	15.8	68.2	20.0	0.244
	4.5 *	8.04	10.1	57.0	2.38	18.0	21.9	95.7	27.2	0.239
70 x 70	6.0 *	10.57	12.9	68.2	2.30	21.5	27.0	119	32.8	0.233
	2.5	5.17	6.59	49.4	2.74	14.1	16.5	78.5	21.2	0.271
	3.0	6.13	7.81	57.5	2.71	16.4	19.4	92.4	24.7	0.270
	3.6 *	7.24	9.23	66.5	2.69	19.0	22.7	108	28.7	0.268
	4.0	7.97	10.1	72.1	2.67	20.6	24.8	119	31.1	0.266
80 x 80	5.0	9.70	12.4	84.6	2.62	24.2	29.6	142	36.7	0.263
	3.0	7.07	9.01	88	3.12	22.0	25.8	140	33.0	0.310
	3.6 *	8.37	10.7	102	3.09	25.5	30.2	165	38.4	0.308
	4.0	9.22	11.7	111	3.07	27.8	33.1	180	41.8	0.306
	5.0	11.30	14.4	131	3.03	32.9	39.7	218	49.7	0.303
	6.0	13.20	16.8	149	2.98	37.3	45.8	252	56.6	0.299
120 x 120	6.3	13.50	17.2	149	2.94	37.1	46.1	261	57.9	0.293
	4.0	14.20	18.1	402	4.71	67.0	78.3	637	101	0.466
	5.0	17.50	22.4	485	4.66	80.9	95.4	778	122	0.463
	6.0	20.70	26.4	562	4.61	93.7	112	913	141	0.459
	6.3	21.40	27.3	572	4.58	95.3	114	955	146	0.453
8.0	26.40	33.6	677	4.49	113	138	1163	175	0.446	

* Sizes not included in EN 10219 Part 2 (1997)

Square Hollow Sections

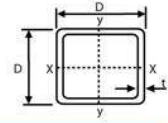

SHS - Size not included in EN 10219/ASTM A500

Designation Size	Thickness	Mass Per Metre	Area Of Section	Second Moment Of Area	Radius Of Gyration	Elastic Modulus	Plastic Modulus	Torsional Constants	Surface Area Per Metre	
DxD	t		A	I	r	Z	S	J	C	
mm	mm	kg/m	cm ²	cm ⁴	cm	cm ³	cm ³	cm ⁴	cm ³	m ² /m
140 x 140	5	21.10	26.7	807	5.50	115	135	1253	170	0.547
	6	25.10	31.8	944	5.45	135	159	1475	198	0.545
	8	32.90	14.6	1195	5.36	171	204	1892	249	0.539
	10	40.40	50.9	1416	5.27	202	246	2272	294	0.534
	12.5	49.50	62.1	1653	5.16	236	293	2696	342	0.528
160 x 160	12.5	57.30	72.1	2576	5.98	322	395	4158	467	0.608
	16	70.20	89.4	3028	5.82	379	476	4988	546	0.599
180 x 180	5.0	27.00	34.4	1737	7.11	193	224	2724	290	0.703
	6.0	32.10	40.8	2037	7.06	226	264	3223	340	0.699
	6.3	33.30	42.4	2096	7.03	233	273	3383	354	0.693
	8.0	41.50	52.8	2546	6.94	283	336	4189	432	0.686
	10.0	50.70	64.6	3017	6.84	335	404	5074	515	0.677
	12.0	58.50	74.5	3322	6.68	369	454	5865	584	0.658
	12.5	50.50	77.0	3406	6.65	378	467	6050	600	0.656
220 x 220	5 *	33.50	42.7	3281	8.76	298	344	5028	442	0.867
	6	40.00	51.0	3875	8.72	352	408	5963	521	0.865
	8	52.70	67.2	5002	8.63	455	532	7765	669	0.859
	10	65.10	82.9	6050	8.54	550	650	9473	807	0.854
	12	77.20	98.3	7023	8.45	638	762	11090	933	0.849
	14 *	88.90	113	7922	8.36	720	868	12620	1049	0.844
260 x 260	6	47.60	60.6	6491	10.4	499	576	9951	740	1.02
	6.3	49.90	63.5	6788	10.3	522	603	10420	773	1.02
	8	62.80	80.0	8423	10.3	648	753	13010	956	1.02
	10	77.70	98.9	10240	10.2	788	924	15930	1159	1.01
	12	92.20	117	11950	10.1	920	1087	18730	1348	1.01
	12.5	95.80	122	12370	10.1	951	1127	19410	1394	1.01
	14 *	106.00	136	13560	10.0	1043	1244	21400	1525	1.00
	14.2 *	108.00	137	13710	9.99	1055	1259	21660	1542	1.00
	16	120.00	153	15060	9.91	1159	1394	23940	1689	1.00
300 x 300	6.3	57.95	73.6	10550	12.0	703	809	16140	1043	1.18
	8	73.10	92.8	13130	11.9	875	1013	20190	1294	1.18
	9 *	81.93	104	14600	11.9	973	1130	22520	1437	1.18
	10	90.70	115	16030	11.8	1068	1246	24810	1575	1.17
	12	107.97	137	18780	11.7	1252	1470	29250	1840	1.17
	12.5	112.00	142	19440	11.7	1296	1525	30330	1904	1.17
	16	142.00	179	23850	11.5	1590	1895	37620	2325	1.16

* Sizes not included in EN 10219 Part 2 (1997)



Rectangular Hollow Sections

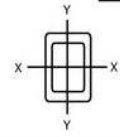

ASTM A 500 Grades A And B/Manufacturer's Standard

SIZE		DIMENSIONS							MOMENT OF INERTIA		SECTION MODULUS		RADIUS OF GYRATION		PLASTIC MODULUS	
NOMINAL	ACTUAL	WALL THICKNESS		CALCULATED WEIGHT				AREA	I _x	I _y	Z _x	Z _y	I _x	I _y	S _x	S _y
mm	in	mm	in	kg/m	kg/6m	kg/ft	lb/ft	in ²	in ⁴	in ⁴	in ³	in ³	in	in	in ³	in ³
19 x 9	3/4 x 3/8	1.0	0.039	0.394	2.363	0.120	0.264	0.0778	0.00528	0.00170	0.0141	0.0091	0.2606	0.1480	0.0181	0.0109
		1.2	0.047	0.462	2.772	0.141	0.310	0.0912	0.00612	0.00194	0.0163	0.0103	0.2589	0.1458	0.0211	0.0126
		1.6	0.063	0.586	3.514	0.179	0.392	0.1156	0.00758	0.00232	0.0202	0.0124	0.2560	0.1420	0.0268	0.0157
25 x 12	1 x 1/2	1.0	0.039	0.555	3.330	0.169	0.373	0.110	0.0138	0.00457	0.0276	0.0183	0.355	0.204	0.0347	0.0211
		1.2	0.047	0.659	3.954	0.201	0.443	0.130	0.0161	0.00526	0.0321	0.0210	0.351	0.201	0.0408	0.0247
		1.6	0.063	0.859	5.154	0.262	0.577	0.170	0.0201	0.00642	0.0401	0.0257	0.344	0.194	0.0519	0.0311
32 x 16	1 1/4 x 5/8	1.0	0.039	0.707	4.240	0.215	0.475	0.140	0.0283	0.0094	0.0453	0.0301	0.4496	0.2591	0.0401	0.0282
		1.2	0.047	0.838	5.028	0.255	0.563	0.166	0.0334	0.0110	0.0534	0.1709	0.4485	0.2574	0.0479	0.0332
		1.6	0.063	1.100	6.600	0.335	0.738	0.217	0.0428	0.0138	0.0685	0.2192	0.4441	0.2522	0.0618	0.0426
38 x 19	1 1/2 x 3/4	1.0	0.039	0.858	5.146	0.261	0.577	0.170	0.4990	0.0168	0.0665	0.0448	0.5418	0.3143	0.0464	0.0352
		1.2	0.047	1.014	6.084	0.309	0.682	0.201	0.0560	0.0197	0.0747	0.0525	0.5278	0.3131	0.0550	0.0417
		1.6	0.063	1.340	8.040	0.408	0.900	0.265	0.0761	0.0249	0.1015	0.0664	0.5201	0.3065	0.0716	0.0542
38 x 25	1 1/2 x 1	1.0	0.039	0.949	5.694	0.289	0.638	0.188	0.0596	0.0318	0.0795	0.0636	0.5640	0.4120	0.0954	0.0722
		1.2	0.047	1.13	6.780	0.346	0.762	0.224	0.0704	0.0374	0.0938	0.0748	0.5600	0.4080	0.1130	0.0855
		1.6	0.063	1.50	9.000	0.456	1.010	0.296	0.0905	0.0478	0.1210	0.0955	0.5530	0.4020	0.1470	0.1110
50 x 25	2 x 1	1.0	0.039	1.15	6.900	0.349	0.770	0.227	0.120	0.0408	0.1200	0.0816	0.7270	0.4240	0.1470	0.0909
		1.2	0.047	1.37	8.220	0.418	0.922	0.271	0.142	0.0481	0.1420	0.0962	0.7240	0.4210	0.1750	0.1080
		1.6	0.063	1.81	10.860	0.553	1.220	0.359	0.184	0.0616	0.1840	0.1230	0.7160	0.4140	0.2290	0.1400
		2.3	0.091	2.48	14.880	0.756	1.670	0.505	0.257	0.0837	0.2570	0.1670	0.7130	0.4070	0.3150	0.1910
		3.0	0.120	3.29	19.740	1.000	2.210	0.650	0.310	0.0995	0.3100	0.1990	0.6900	0.3910	0.3990	0.2400
		3.2	0.125	3.41	20.460	1.040	2.290	0.674	0.319	0.1020	0.3190	0.2040	0.6880	0.3890	0.4130	0.2480
65 x 38	2 1/2 x 1 1/2	1.6	0.063	2.45	14.700	0.747	1.65	0.485	0.416	0.189	0.333	0.252	0.920	0.620	0.582	0.411
		2.3	0.091	3.40	20.377	1.04	2.282	0.692	0.550	0.248	0.439	0.331	0.912	0.611	0.598	0.426
		3.0	0.120	4.38	26.280	1.33	2.94	0.865	0.685	0.307	0.548	0.409	0.890	0.595	0.689	0.482
		3.2	0.125	4.54	27.240	1.38	3.05	0.897	0.706	0.316	0.565	0.421	0.887	0.593	0.712	0.498
75 x 38	3 x 1 1/2	1.6	0.063	2.70	16.221	0.82	1.86	0.527	0.60	0.209	0.400	0.279	1.07	0.630	0.612	0.467
		1.9	0.075	3.22	19.341	0.98	2.17	0.629	0.72	0.246	0.480	0.328	1.06	0.623	0.638	0.487
		2.3	0.091	3.86	23.127	1.18	2.60	0.762	0.86	0.293	0.573	0.391	1.06	0.620	0.683	0.522
		3.0	0.120	4.99	29.940	1.52	3.35	0.985	1.09	0.364	0.724	0.485	1.05	0.608	0.921	0.565
		3.2	0.125	5.17	31.020	1.58	3.48	1.02	1.12	0.375	0.747	0.500	1.05	0.606	0.952	0.584

Rectangular Hollow Sections

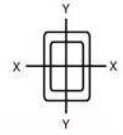

ASTM A 500 Grades A And B/Manufacturer's Standard

SIZE		DIMENSIONS							MOMENT OF INERTIA		SECTION MODULUS		RADIUS OF GYRATION		PLASTIC MODULUS	
		WALL THICKNESS		CALCULATED WEIGHT				AREA								
NOMINAL	ACTUAL								lx	ly	Zx	Zy	lx	ly	Sx	Sy
mm	in	mm	in	kg/m	kg/6m	kg/ft	lb/ft	in ²	in ⁴	in ⁴	in ³	in ³	in	in	in ³	in ³
75 x 50	3 x 2	1.9	0.075	3.60	21.618	1.10	2.42	0.714	0.88	0.486	0.587	0.486	1.12	0.825	0.85	0.650
		2.3	0.091	4.31	25.878	1.32	2.90	0.863	1.06	0.578	0.707	0.578	1.11	0.818	0.91	0.696
		3.0	0.120	5.59	33.540	1.70	3.76	1.11	1.34	0.711	0.890	0.711	1.10	0.802	1.09	0.826
		3.2	0.125	5.80	34.800	1.77	3.90	1.15	1.38	0.733	0.920	0.733	1.10	0.800	1.13	0.855
		4.0	0.156	7.08	42.480	2.16	4.76	1.40	1.63	0.864	1.09	0.864	1.08	0.785	1.36	1.02
		4.5	0.177	7.88	47.271	2.40	5.30	1.58	1.82	0.958	1.21	0.958	1.07	0.778	1.50	1.12
		6.0	0.236	10.10	60.590	3.04	6.77	1.99	2.27	1.162	1.52	1.162	1.07	0.763	1.94	1.43
100 x 50	4 x 2	1.9	0.075	4.36	26.163	1.33	2.93	0.85	1.77	0.612	0.885	0.612	1.44	0.848	1.26	0.78
		2.3	0.091	5.23	31.387	1.60	3.52	1.03	2.14	0.732	1.070	0.732	1.44	0.843	1.47	0.90
		3.0	0.120	6.81	40.860	2.07	4.57	1.35	2.73	0.932	1.36	0.923	1.42	0.828	1.71	1.05
		3.2	0.125	7.07	42.420	2.15	4.75	1.40	2.82	0.954	1.41	0.954	1.42	0.826	1.77	1.09
		4.0	0.156	8.66	51.960	2.64	5.82	1.71	3.37	1.13	1.68	1.13	1.40	0.812	2.14	1.31
		4.5	0.177	9.70	58.191	2.95	6.52	1.92	3.64	1.23	1.84	1.23	1.39	0.803	2.36	1.44
		5.0	0.197	10.76	64.555	3.26	7.21	2.13	4.06	1.34	2.03	1.34	1.38	0.793	2.63	1.61
6.0	0.236	12.78	76.678	3.87	8.56	2.52	4.75	1.54	2.38	1.54	1.37	0.781	3.15	1.93		
100 x 75	4 x 3	3.0	0.120	8.02	48.120	2.44	5.39	1.59	3.63	2.33	1.81	1.55	1.51	1.21	2.17	1.78
		3.2	0.125	8.33	49.980	2.54	5.60	1.65	3.76	2.41	1.88	1.61	1.51	1.21	2.25	1.85
		4.0	0.156	10.2	61.200	3.12	6.88	2.02	4.52	2.90	2.26	1.93	1.49	1.20	2.74	2.25
		4.5	0.177	11.5	69.105	3.51	7.74	2.27	4.99	3.19	2.50	2.13	1.48	1.19	3.03	2.50
		5.0	0.197	12.8	76.582	3.88	8.55	2.52	5.50	3.50	2.75	2.33	1.477	1.18	3.38	2.78
		6.0	0.236	14.88	89.273	4.54	9.98	2.94	6.28	3.96	3.14	2.64	1.463	1.16	3.89	3.16
125 x 50	5 x 2	3.0	0.120	8.02	48.120	2.44	5.39	1.59	4.79	1.14	1.92	1.14	1.74	0.846	2.44	1.28
		3.2	0.125	8.33	49.980	2.54	5.60	1.65	4.96	1.17	1.98	1.17	1.73	0.844	2.53	1.32
		4.0	0.156	10.2	61.200	3.12	6.88	2.02	5.96	1.40	2.38	1.40	1.72	0.830	3.07	1.60
		4.5	0.177	11.5	69.105	3.51	7.74	2.27	6.57	1.52	2.63	1.52	1.70	0.820	3.41	1.77
		5.0	0.197	12.8	76.582	3.88	8.55	2.52	7.24	1.67	2.90	1.67	1.69	0.814	3.79	1.97
		6.0	0.236	14.88	89.273	4.54	9.98	2.94	8.39	1.85	3.35	1.85	1.69	0.793	4.39	2.21
125 x 75	5 x 3	3.0	0.120	9.23	55.380	2.81	6.21	1.83	6.22	2.83	2.49	1.89	1.85	1.25	3.02	2.13
		3.2	0.125	9.60	57.600	2.93	6.45	1.90	6.44	2.93	2.58	1.95	1.84	1.24	3.14	2.21
		4.0	0.156	11.8	70.800	3.60	7.94	2.34	7.79	3.53	3.12	2.35	1.83	1.23	3.83	2.69
		4.5	0.177	13.3	79.874	4.06	8.95	2.63	8.93	3.90	3.45	2.60	1.81	1.22	4.26	2.99
		5.0	0.197	14.7	88.245	4.48	9.89	2.92	9.53	4.28	3.81	2.85	1.80	1.21	4.73	3.33
		6.0	0.236	17.2	103.116	5.22	11.5	3.47	11.2	4.98	4.48	3.32	1.79	1.19	5.37	3.98
		9.0	0.354	24.5	147.08	7.47	16.4	4.84	15.03	6.46	6.01	4.31	1.76	1.16	7.71	5.28
150 x 50	6 x 2	3.0	0.120	9.23	55.380	2.81	6.21	1.83	7.64	1.35	2.55	1.35	2.05	0.859	3.29	1.50
		3.2	0.125	9.60	57.600	2.93	6.45	1.90	7.92	1.39	2.64	1.39	2.04	0.857	3.42	1.56
		4.0	0.156	11.8	70.800	3.60	7.94	2.34	9.56	1.66	3.19	1.66	2.02	0.843	4.16	1.89
		4.5	0.177	13.3	79.874	4.06	8.95	2.63	10.5	1.82	3.50	1.82	2.01	0.838	4.63	2.09
		5.0	0.197	14.7	88.245	4.48	9.89	2.92	11.6	1.99	3.88	1.99	1.99	0.826	5.15	2.33
		6.0	0.236	17.3	103.71	5.23	11.6	3.47	13.1	2.21	4.36	2.21	1.96	0.818	5.83	2.60



Rectangular Hollow Sections

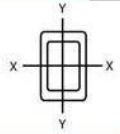

ASTM A 500 Grades A And B/Manufacturer's Standard

SIZE		DIMENSIONS							MOMENT OF INERTIA		SECTION MODULUS		RADIUS OF GYRATION		PLASTIC MODULUS	
NOMINAL	ACTUAL	WALL THICKNESS		CALCULATED WEIGHT				AREA	I _x	I _y	Z _x	Z _y	I _x	I _y	S _x	S _y
mm	in	mm	in	kg/m	kg/6m	kg/ft	lb/ft	in ²	in ⁴	in ⁴	in ³	in ³	in	in	in ³	in ³
150 x 75	6 x 3	3.2	0.125	10.9	65.357	3.32	7.32	2.13	10.1	3.44	3.35	2.30	2.17	1.27	3.99	2.47
		4.0	0.156	13.4	80.544	4.09	9.02	2.65	12.2	4.15	4.07	2.76	2.15	1.25	4.98	3.08
		4.5	0.177	15.1	90.634	4.60	10.2	2.98	13.6	4.60	4.53	3.07	2.13	1.24	5.66	3.49
		5.0	0.197	16.7	100.28	5.10	11.3	3.31	15.0	5.05	5.00	3.37	2.13	1.24	6.30	3.89
		6.0	0.236	19.7	118.07	6.00	13.2	3.87	17.0	5.72	5.67	3.81	2.10	1.22	7.19	4.40
		9.0	0.354	28.1	168.59	8.56	18.8	5.55	23.9	7.62	7.97	5.08	2.07	1.17	10.30	6.16
150 x 100	6 x 4	4.0	0.156	15.0	90.00	4.57	10.1	2.96	14.9	7.96	4.96	3.98	2.24	1.64	5.91	4.45
		4.5	0.177	16.9	101.40	5.15	11.4	3.33	16.5	8.87	5.50	4.44	2.23	1.63	6.70	5.06
		5.0	0.197	18.7	112.26	5.71	12.6	3.70	18.3	9.77	6.10	4.89	2.22	1.62	7.45	5.64
		6.0	0.236	22.1	132.42	6.73	14.8	4.34	21.0	11.1	7.00	5.55	2.20	1.60	8.55	6.45
		9.0	0.354	31.7	190.37	9.67	21.3	6.26	29.2	15.1	9.72	7.57	2.16	1.55	12.2	9.09
		12.0	0.472	40.8	242.3	12.3	27.1	7.98	36.4	18.6	12.1	9.3	2.14	1.53	15.5	11.5
175 x 100	7 x 4	4.5	0.177	18.4	110.3	5.6	12.3	3.63	22.3	9.30	6.5	4.7	2.48	1.60	7.96	5.39
		6.0	0.236	24.0	114.3	7.3	16.1	4.75	28.8	11.9	8.4	6.1	2.46	1.58	10.40	7.00
		9.0	0.354	34.7	208.1	10.6	23.3	6.85	40.7	16.5	11.8	8.4	2.44	1.55	14.94	9.96
		12.0	0.472	44.4	266.3	13.5	29.8	8.76	51.1	20.3	14.8	10.3	2.41	1.52	19.08	12.60
175 x 125	7 x 5	4.5	0.177	20.1	120.9	6.1	13.5	3.98	26.0	15.4	7.5	6.3	2.55	1.97	9.06	7.19
		6.0	0.236	26.4	158.4	8.0	17.7	5.21	33.6	19.9	9.8	8.1	2.54	1.95	11.85	9.37
		9.0	0.354	38.2	299.3	11.6	25.6	7.54	47.7	27.8	13.8	11.3	2.51	1.92	17.09	13.44
		12.0	0.472	49.1	294.5	15.0	32.9	9.69	60.0	34.7	17.4	14.1	2.49	1.89	21.89	17.14
200 x 100	8 x 4	4.5	0.177	20.5	122.9	6.25	13.8	4.04	32.0	10.9	8.12	5.55	2.89	1.69	10.4	6.42
		5.0	0.197	22.7	135.9	6.90	15.2	4.48	37.0	12.6	9.25	6.28	2.87	1.67	11.6	6.90
		6.0	0.236	26.9	161.4	8.19	18.0	5.21	40.8	13.9	10.4	7.02	2.82	1.66	13.8	8.23
		9.0	0.354	38.2	229.3	11.6	25.6	7.54	56.9	18.6	14.5	9.4	2.75	1.57	18.42	11.14
		12.0	0.472	49.1	294.5	15.0	32.9	9.69	71.9	22.9	18.3	11.6	2.72	1.54	23.62	14.11
200 x 150	8 x 6	4.5	0.177	23.7	142.1	7.22	15.9	4.68	40.5	26.0	10.4	8.8	2.94	2.36	12.28	10.08
		6.0	0.236	31.1	186.7	9.5	20.9	6.14	52.7	33.7	13.4	11.4	2.93	2.34	16.11	13.20
		9.0	0.354	45.3	271.6	13.8	30.4	8.94	75.3	47.8	19.1	16.2	2.90	2.31	23.36	19.07
		12.0	0.472	58.5	351.1	17.8	39.2	11.55	95.6	60.2	24.3	20.4	2.88	2.28	30.09	24.48
250 x 150	10 x 6	6.0	0.236	35.8	214.9	10.9	24.0	7.07	93.5	42.5	19.0	14.4	3.63	2.45	23.07	16.2
		9.0	0.354	52.3	314.0	16.0	35.3	10.33	131.7	59.3	26.7	20.1	3.57	2.40	33.07	23.19
300 x 200	14 x 8	6.0	0.236	45.2	271.5	13.8	30.3	8.93	177.1	95.1	30.0	24.2	4.45	3.26	35.88	27.22
		9.0	0.354	66.5	398.8	20.3	44.6	13.12	252.3	135.3	42.8	34.4	4.41	3.21	51.93	39.30



Rectangular Hollow Sections

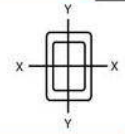

ASTM A 500 Grades A And B/Manufacturer's Standard

SIZE		DIMENSIONS							MOMENT OF INERTIA		SECTION MODULUS		RADIUS OF GYRATION		PLASTIC MODULUS	
NOMINAL	ACTUAL	WALL THICKNESS		CALCULATED WEIGHT				AREA	I _x	I _y	Z _x	Z _y	I _x	I _y	S _x	S _y
mm	in	mm	in	kg/m	kg/6m	kg/ft	lb/ft	in ²	in ⁴	in ⁴	in ³	in ³	in	in	in ³	in ³
150 x 75	6 x 3	3.2	0.125	10.9	65.357	3.32	7.32	2.13	10.1	3.44	3.35	2.30	2.17	1.27	3.99	2.47
		4.0	0.156	13.4	80.544	4.09	9.02	2.65	12.2	4.15	4.07	2.76	2.15	1.25	4.98	3.08
		4.5	0.177	15.1	90.634	4.60	10.2	2.98	13.6	4.60	4.53	3.07	2.13	1.24	5.66	3.49
		5.0	0.197	16.7	100.28	5.10	11.3	3.31	15.0	5.05	5.00	3.37	2.13	1.24	6.30	3.89
		6.0	0.236	19.7	118.07	6.00	13.2	3.87	17.0	5.72	5.67	3.81	2.10	1.22	7.19	4.40
		9.0	0.354	28.1	168.59	8.56	18.8	5.55	23.9	7.62	7.97	5.08	2.07	1.17	10.30	6.16
150 x 100	6 x 4	4.0	0.156	15.0	90.00	4.57	10.1	2.96	14.9	7.96	4.96	3.98	2.24	1.64	5.91	4.45
		4.5	0.177	16.9	101.40	5.15	11.4	3.33	16.5	8.87	5.50	4.44	2.23	1.63	6.70	5.06
		5.0	0.197	18.7	112.26	5.71	12.6	3.70	18.3	9.77	6.10	4.89	2.22	1.62	7.45	5.64
		6.0	0.236	22.1	132.42	6.73	14.8	4.34	21.0	11.1	7.00	5.55	2.20	1.60	8.55	6.45
		9.0	0.354	31.7	190.37	9.67	21.3	6.26	29.2	15.1	9.72	7.57	2.16	1.55	12.2	9.09
		12.0	0.472	40.8	242.3	12.3	27.1	7.98	36.4	18.6	12.1	9.3	2.14	1.53	15.5	11.5
175 x 100	7 x 4	4.5	0.177	18.4	110.3	5.6	12.3	3.63	22.3	9.30	6.5	4.7	2.48	1.60	7.96	5.39
		6.0	0.236	24.0	114.3	7.3	16.1	4.75	28.8	11.9	8.4	6.1	2.46	1.58	10.40	7.00
		9.0	0.354	34.7	208.1	10.6	23.3	6.85	40.7	16.5	11.8	8.4	2.44	1.55	14.94	9.96
		12.0	0.472	44.4	266.3	13.5	29.8	8.76	51.1	20.3	14.8	10.3	2.41	1.52	19.08	12.60
175 x 125	7 x 5	4.5	0.177	20.1	120.9	6.1	13.5	3.98	26.0	15.4	7.5	6.3	2.55	1.97	9.06	7.19
		6.0	0.236	26.4	158.4	8.0	17.7	5.21	33.6	19.9	9.8	8.1	2.54	1.95	11.85	9.37
		9.0	0.354	38.2	299.3	11.6	25.6	7.54	47.7	27.8	13.8	11.3	2.51	1.92	17.09	13.44
		12.0	0.472	49.1	294.5	15.0	32.9	9.69	60.0	34.7	17.4	14.1	2.49	1.89	21.89	17.14
200 x 100	8 x 4	4.5	0.177	20.5	122.9	6.25	13.8	4.04	32.0	10.9	8.12	5.55	2.89	1.69	10.4	6.42
		5.0	0.197	22.7	135.9	6.90	15.2	4.48	37.0	12.6	9.25	6.28	2.87	1.67	11.6	6.90
		6.0	0.236	26.9	161.4	8.19	18.0	5.21	40.8	13.9	10.4	7.02	2.82	1.66	13.8	8.23
		9.0	0.354	38.2	229.3	11.6	25.6	7.54	56.9	18.6	14.5	9.4	2.75	1.57	18.42	11.14
		12.0	0.472	49.1	294.5	15.0	32.9	9.69	71.9	22.9	18.3	11.6	2.72	1.54	23.62	14.11
200 x 150	8 x 6	4.5	0.177	23.7	142.1	7.22	15.9	4.68	40.5	26.0	10.4	8.8	2.94	2.36	12.28	10.08
		6.0	0.236	31.1	186.7	9.5	20.9	6.14	52.7	33.7	13.4	11.4	2.93	2.34	16.11	13.20
		9.0	0.354	45.3	271.6	13.8	30.4	8.94	75.3	47.8	19.1	16.2	2.90	2.31	23.36	19.07
		12.0	0.472	58.5	351.1	17.8	39.2	11.55	95.6	60.2	24.3	20.4	2.88	2.28	30.09	24.48
250 x 150	10 x 6	6.0	0.236	35.8	214.9	10.9	24.0	7.07	93.5	42.5	19.0	14.4	3.63	2.45	23.07	16.2
		9.0	0.354	52.3	314.0	16.0	35.3	10.33	131.7	59.3	26.7	20.1	3.57	2.40	33.07	23.19
300 x 200	14 x 8	6.0	0.236	45.2	271.5	13.8	30.3	8.93	177.1	95.1	30.0	24.2	4.45	3.26	35.88	27.22
		9.0	0.354	66.5	398.8	20.3	44.6	13.12	252.3	135.3	42.8	34.4	4.41	3.21	51.93	39.30

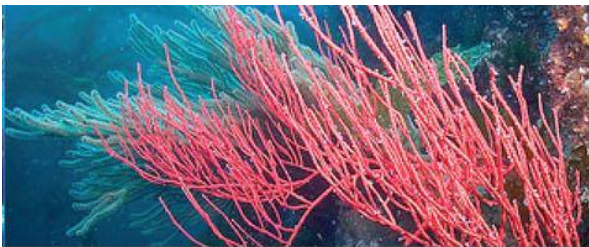

Rectangular Hollow Sections

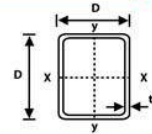

RHS - Sizes not included in ASTM A500 / EN 10219

Designation Size	Thickness t	Mass Per Metre kg/m	Area Of Section A cm ²	Second Moment Of Area		Radius Of Gyration		Elastic Modulus		Plastic Modulus		Torsional Constants		Surface Area Per Metre m ² /m
				x-x Axis	y-y Axis	x-x Axis	y-y Axis	x-x Axis	y-y Axis	x-x Axis	y-y Axis	J cm ⁴	C cm ³	
160 x 80	5.0	17.50	22.4	722	244	5.68	3.30	90.2	61.0	113	69.7	601	106	0.463
	6.0	20.70	26.4	836	281	5.62	3.26	105	70.2	132	81.3	702	122	0.459
	8.0	26.40	33.6	1001	335	5.46	3.16	125	83.7	163	100	882	150	0.446
300 x 100	5.0	35.5	45.6	4777	842	10	4.30	318	168	411	188	2403	306	0.779
	6.3	37.2	47.4	4907	86	10	4.28	327	174	425	194	2515	318	0.773
	10.0	57.0	72.6	7106	1224	10	4.11	474	245	631	285	3681	455	0.757
300 x 200	6	45.80	58.2	7486	4013	11.3	8.31	499	401	596	451	8100	651	0.985
	6.3	48.10	61.0	7829	4193	11.3	8.29	522	419	624	472	8476	681	0.984
	8	60.50	76.8	9717	5184	11.3	8.22	648	518	779	589	10560	840	0.979
	10	75.00	94.9	11820	6278	11.2	8.13	788	628	956	751	12910	1015	0.974
	12	89.15	113	13800	7294	11.1	8.05	920	729	1124	847	15140	1178	0.969
	12.5	92.60	117	14270	7537	11.0	8.02	952	754	1165	877	15680	1217	0.968
400 x 200	6.0 *	54.70	69.6	14790	5092	14.6	8.55	739	509	906	562	12070	877	1.18
	8.0	71.60	91.2	18970	6517	14.4	8.45	949	652	1173	728	15820	1133	1.17
	9.0 *	80.60	102	21020	7204	14.4	8.40	101	720	1305	809	17620	1255	1.16
	10.0 *	88.40	113	23000	7864	14.3	8.36	1150	786	1434	888	19370	1373	1.16
	12.0 *	104.00	132	26250	8977	14.1	8.24	1312	898	1656	1027	22780	1591	1.14
	12.5	108.00	137	27100	9260	14.4	8.22	1355	926	1714	1062	23590	1644	1.14
450 x 250	8	85.40	109	30080	12140	16.6	10.6	1337	971	1622	1081	27080	1629	1.38
	10	106.00	135	36900	14820	16.5	10.5	1640	1185	2000	1331	33280	1986	1.37
	12.5	132.00	167	45030	17970	16.4	10.4	2001	1438	2458	1631	40720	2406	1.37
	16	167.00	211	55710	22040	16.2	10.2	2476	1763	3070	2029	50550	2947	1.36

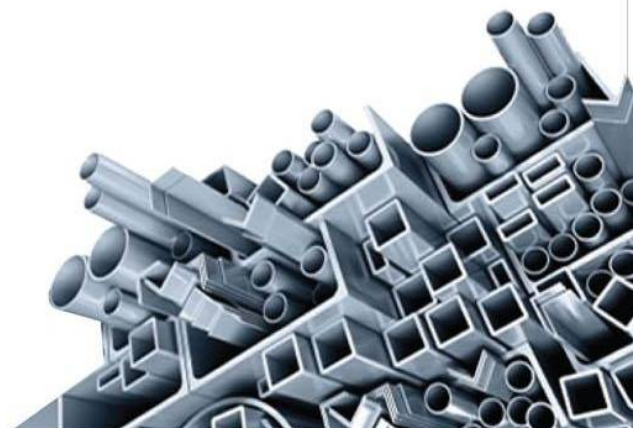

Mild Steel Plain Channels

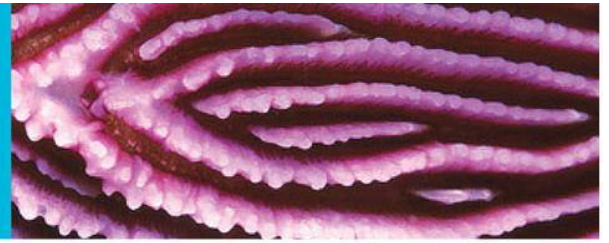

25

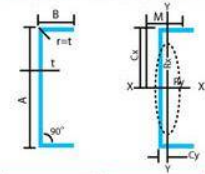

JIS G 3350:1987 / Manufacturer's Standard

DIMENSION		AREA	WEIGHT	POSITION OF CENTROID		MOMENT OF INERTIA		RADIUS OF GYRATION		SECTIONAL MODULUS		MOMENT CAPACITY	SHEAR CENTRE	COLUMN FACTOR
A X B mm	t mm	Ar cm ²	W kg/m	Cx cm	Cy cm	Ix cm ⁴	Iy cm ⁴	Rx cm	Ry cm	Zx cm ³	Zy cm ³	Mx kg/m	M cm	Q
60 X 30	1.6	1.83	1.44	0.82	3.00	10.33	1.63	2.37	0.94	3.44	0.75	46.08	1.12	0.77
	2.3	2.58	2.03	0.85	3.00	15.13	2.25	2.33	0.93	4.71	1.05	76.97	1.12	0.96
75 X 45	1.6	2.55	2.00	1.30	3.75	23.86	5.38	3.05	1.45	6.36	1.68	53.04	1.76	0.46
	2.3	3.62	2.84	1.33	3.75	33.08	7.51	3.02	1.44	8.82	2.37	114.32	1.76	0.76
	3.0	4.75	3.65	1.37	3.75	41.58	9.51	2.98	1.42	11.08	3.04	169.91	1.76	0.90
100 X 50	1.6	3.11	2.44	1.32	5.00	50.00	7.88	4.00	1.59	10.00	2.14	66.48	1.87	0.33
	2.3	4.42	3.47	1.35	5.00	69.83	11.05	3.97	1.58	13.96	3.03	165.23	1.87	0.66
	3.0	5.70	4.47	1.38	5.00	88.45	14.05	3.93	1.56	17.69	3.89	255.77	1.87	0.85
125 X 50	2.3	5.00	3.92	1.21	6.25	117.36	11.84	4.84	1.53	18.77	3.12	222.17	1.76	0.61
	3.0	6.45	5.06	1.24	6.25	149.25	15.07	4.80	1.52	23.88	5.01	345.27	1.75	0.81
	4.5	9.45	7.42	1.31	6.25	211.76	31.43	4.73	1.50	33.88	5.81	571.75	1.75	1.00
150 X 65	2.3	6.26	4.91	1.61	7.50	218.16	25.86	5.90	2.03	29.08	5.29	239.92	2.34	0.40
	3.0	8.10	6.36	1.64	7.50	278.84	33.12	5.86	2.02	37.17	6.82	441.26	2.34	0.63
	4.0	10.67	8.38	1.67	7.50	372.62	43.63	5.81	2.01	49.68	9.03	790.21	2.34	0.79
	4.5	11.93	9.36	1.71	7.50	400.15	47.69	5.79	1.99	53.35	9.96	832.81	2.34	0.91
175 X 75	2.3	7.30	5.73	1.83	8.75	346.87	40.19	6.89	2.34	39.64	7.09	240.68	2.69	0.28
	3.0	9.45	7.42	1.86	8.75	444.65	51.59	6.85	2.33	50.81	9.15	515.38	2.69	0.51
	4.0	12.47	9.79	1.89	8.75	593.94	68.05	6.81	2.32	67.88	12.13	959.20	2.69	0.73
	4.5	13.95	10.95	1.93	8.75	642.23	74.74	6.78	2.31	73.39	13.42	1061.21	2.69	0.82
200 X 75	2.3	7.87	6.18	1.70	10.00	473.31	41.76	7.75	2.30	47.33	7.21	287.35	2.48	0.26
	3.0	10.20	8.01	1.73	10.00	607.58	53.63	7.71	2.29	60.75	9.31	616.21	2.58	0.48
	4.0	13.47	10.58	1.76	10.00	812.25	70.68	7.67	2.28	81.23	12.31	1174.44	2.58	0.70
	4.5	15.08	15.08	1.80	10.00	880.30	77.78	7.63	2.27	88.03	13.65	1272.76	2.58	0.79
225 X 75	2.3	8.45	6.63	1.59	11.25	624.36	43.12	8.59	2.25	55.49	7.30	336.94	2.49	0.24
	3.0	10.95	8.59	1.63	11.25	802.40	55.40	8.55	2.24	71.32	9.43	723.37	2.48	0.45
	4.0	14.47	11.36	1.65	11.25	1073.31	72.95	8.50	2.23	95.41	12.47	1355.64	2.48	0.68
	4.5	16.20	12.72	1.69	11.25	1145.51	80.39	8.47	2.22	103.60	13.85	1497.89	2.48	0.76
250 X 75	2.3	9.02	7.08	1.50	12.50	801.81	44.31	9.42	2.21	64.14	7.39	389.44	2.39	0.23
	3.0	11.70	9.18	1.53	12.50	1031.46	56.94	9.38	2.20	82.51	9.54	836.88	2.39	0.43
	4.0	15.47	12.15	1.56	12.50	1380.24	74.94	9.33	2.19	110.42	12.55	1610.08	2.39	0.64
	4.5	17.33	13.60	1.60	12.50	1501.38	82.67	9.30	2.18	120.11	14.01	1736.58	2.39	0.72



Mild Steel Lipped Channels

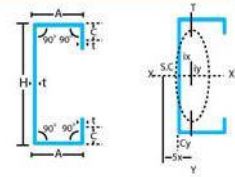

JIS G 3350:1987 / Manufacturer's Standard

DIMENSION mm (inches)		SECTIONAL AREA cm ²	UNIT WEIGHT kg/m	CENTRE OF GRAVITY CM		SECONDARY MOMENT OF AREA cm ⁴		RADIUS GYRATION OF AREA cm		MODULUS OF SECTION cm ³		CENTRE OF SHEAR cm	
HX A x C	t			Cx	Cy	Ix	Iy	ix	iy	Zx	Zy	Sx	Sy
100 x 50 x 20 (4 x 2 x 3/4)	4.5	9.469	7.43	0	1.86	139	30.9	3.82	1.81	27.7	9.82	4.3	0
	4.0	8.548	6.71	0	1.86	127	28.7	3.85	1.83	25.4	9.13	4.3	0
	3.2	7.007	5.50	0	1.86	107	24.5	3.90	1.87	21.3	7.81	4.4	0
	3.0	6.608	5.19	0	1.86	101.5	23.6	3.92	1.89	20.3	7.52	4.4	0
	2.3	5.172	4.06	0	1.86	80.7	19.0	3.95	1.92	16.1	6.06	4.4	0
125 x 50 x 20 (5 x 2 x 3/4)	4.5	10.59	8.32	0	1.68	238	33.5	4.74	1.78	38.0	10.0	4.0	0
	4.0	9.548	7.50	0	1.68	217	33.1	4.77	1.81	34.7	9.38	4.0	0
	3.2	7.807	6.13	0	1.68	181	26.6	4.82	1.85	29.0	8.02	4.0	0
	3.0	7.36	5.78	0	1.68	170	25.5	4.80	1.86	27.1	7.68	4.0	0
	2.3	5.747	4.51	0	1.69	137	20.6	4.88	1.89	21.9	6.22	4.1	0
150x 65 x 20 (6 x 3 1/2 x 3/4)	4.5	13.06	10.25	0	2.10	441	68.8	5.80	2.29	58.8	15.6	5.0	0
	4.0	11.75	9.22	0	2.11	401	63.7	5.84	2.33	53.5	14.5	5.0	0
	3.2	9.567	7.51	0	2.11	332	53.8	5.89	2.37	44.3	12.2	5.1	0
	3.0	9.01	7.07	0	2.11	342	51.5	5.91	2.39	42.0	11.7	5.1	0
	2.3	7.012	5.50	0	2.12	248	41.1	5.94	2.42	33.0	9.37	5.2	0
175x 75 x 20 (7 x 3 x 3/4)	4.5	15.09	11.8	0	2.33	702	104	6.81	2.62	80.2	20.1	5.63	0
	3.2	11.00	8.64	0	2.34	521	79.6	6.88	2.69	59.5	15.4	5.66	0
	3.0	10.35	8.13	0	2.34	495	76.3	6.91	2.71	56.6	14.8	5.67	0
	2.3	8.047	6.31	0	2.34	389	61.0	6.95	2.75	44.5	11.8	5.68	0
200x 75 x 20 (9 x 3 x 3/4)	4.5	16.22	12.7	0	2.19	963	109	7.71	2.60	96.3	20.6	5.3	0
	4.0	14.55	11.7	0	2.19	871	100	7.74	2.62	87.1	18.9	5.3	0
	3.2	11.81	9.27	0	2.19	716	84.1	7.79	2.67	71.6	15.8	5.4	0
	3.0	11.10	8.72	0	2.20	676	80.4	7.80	2.69	67.6	15.2	5.4	0
200x 75 x 25 (9 x 3 x 1)	4.5	16.67	13.1	0	2.32	990	121	7.71	2.69	99.0	23.3	5.6	0
	4.0	14.95	11.7	0	2.32	895	110	7.74	2.72	89.5	21.3	5.7	0
	3.2	12.13	9.52	0	2.33	736	92.3	7.79	2.76	73.6	17.8	5.7	0
	3.0	11.41	8.96	0	2.33	694	88.2	7.80	2.78	69.4	17.1	5.8	0
225 x 75 x 20 (9 x 3 x 3/4)	4.5	17.34	13.6	0	2.05	1273	113	8.56	2.55	113	20.7	5.10	0
	4.0	15.53	12.19	0	2.06	1151	105.8	8.61	2.61	102.3	19.5	5.12	0
	3.2	12.61	9.90	0	2.06	943.3	86.5	8.65	2.62	83.8	15.9	5.13	0
	3.0	11.85	9.30	0	2.06	892.0	82.6	8.67	2.63	79.3	15.2	5.13	0
	2.3	9.197	7.21	0	2.06	699.6	66.0	8.72	2.67	62.2	12.1	5.14	0
225 x 75 x 25 (9 x 3 x 1)	4.5	17.79	14.0	0	2.18	1310	125	8.57	2.64	116	23.5	5.33	0
	4.0	15.92	12.5	0	2.19	1182	115.9	8.62	2.70	105.9	21.8	5.40	0
	3.2	12.93	10.15	0	2.19	969.5	95.6	8.66	2.72	86.2	18.0	5.42	0
	3.0	12.15	9.54	0	2.19	916.3	90.7	8.68	2.73	81.5	17.1	5.43	0
	2.3	9.427	7.40	0	2.19	718.2	72.3	8.72	2.77	63.8	13.6	5.44	0
250 x 75 x 20 (10 x 3 3/4)	4.5	18.46	14.5	0	1.94	1638	116	9.41	2.51	131	21.0	4.94	0
	4.0	16.51	12.96	0	1.95	1477	109.1	9.46	2.57	118.2	19.7	4.97	0
	3.2	13.41	10.52	0	1.95	1210	89.2	9.50	2.58	96.8	16.1	4.99	0
	3.0	12.60	9.89	0	1.95	1145	85.1	9.52	2.59	91.6	15.3	5.00	0
250 x 75 x 25 (10 x 3 x 1)	4.5	18.92	14.9	0	2.07	1690	129	9.44	2.62	135	23.8	5.1	0
	4.0	16.90	13.0	0	2.07	1518	120	9.48	2.66	121.4	22.0	5.2	0
	3.2	13.96	10.96	0	2.07	1265	100	9.52	2.68	101.2	18.4	5.2	0
	3.0	12.90	10.1	0	2.07	1177	94	9.54	2.69	94.1	17.3	5.2	0

10" lipped channels are also available upon request.

Decorative Hollow Sections



27

Decorative Hollow Section Manufacturer's Standard Wrought / Oval / Hexagon / String Tubes

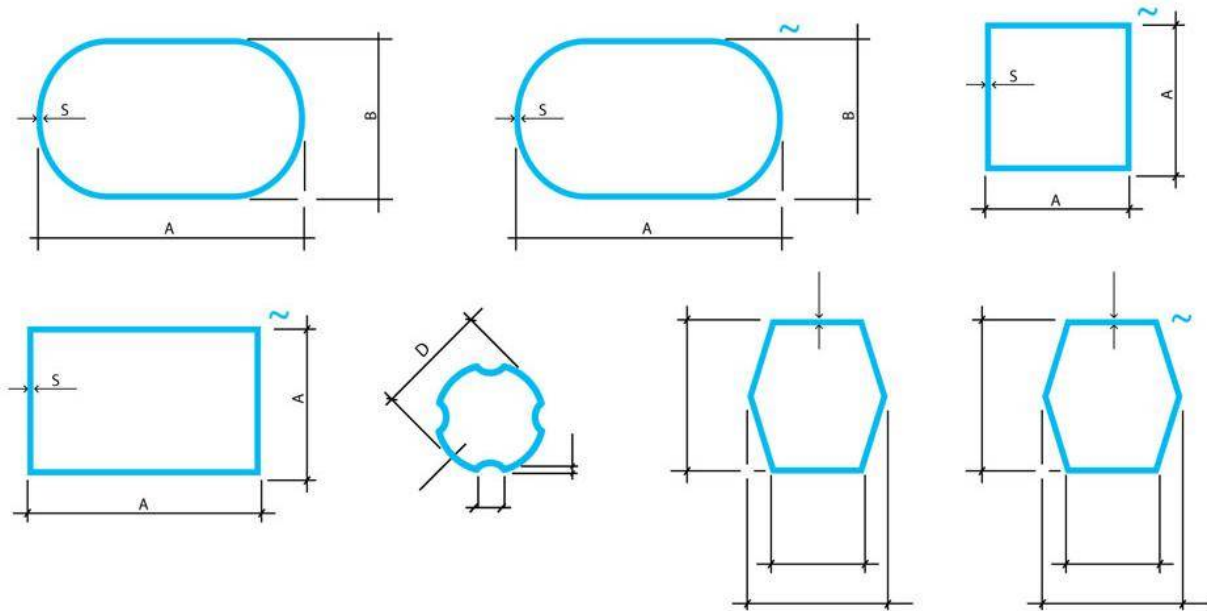

Other Cold-Rolled Section Manufacturer's Standard Door Rail Track / Trolley Track / Channel / Wrought Angles

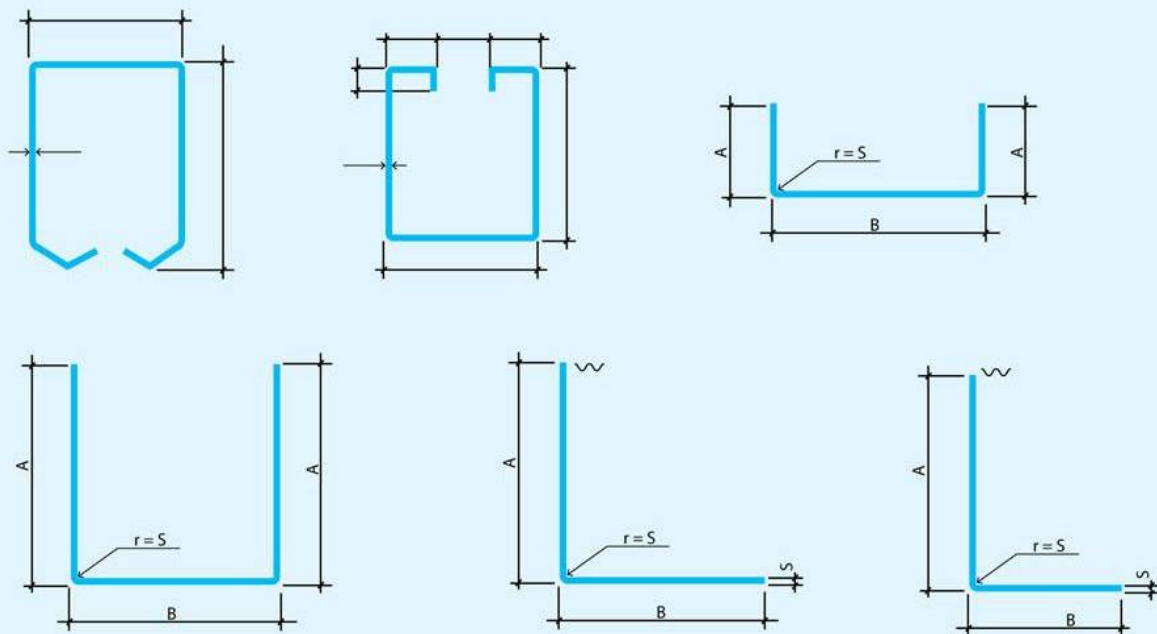



Equal Angle Sections

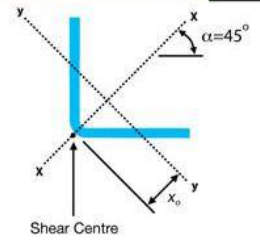

Japmas Equal Angle Sections Section Properties For Member Stability Grade C400I0/c450I0 About Principal X- And Y-axes

Designation			Mass per metre	Torsion Constant J	Coordinate of Shear Centre X ₀	Polar Radius of Gyration about the Shear Centre r _{o1}	Monosymmetry Section Constant β _y
Leg b ₁	Nominal Size b ₂	Thick-ness					
mm	mm	mm	kg/m	10 ⁸ mm ⁴	mm	mm	mm
30	30	2.5 CA	1.06	0.258	10.2	16.6	40.7
40	40	4.0 CA	2.20	1.35	13.5	22.0	53.9
		2.5 CA	1.43	0.350	13.7	22.4	54.9
45	45	4.0 CA	2.50	1.53	15.2	24.9	61.0
		2.5 CA	1.62	0.396	15.5	25.3	61.9
50	6.0	CA	4.21	6.43	16.6	27.1	66.5
		5.0 CA	3.42	3.20	16.8	27.5	67.4
		4.0 CA	2.79	1.71	17.0	27.8	68.0
		2.5 CA	1.81	0.442	17.3	28.2	69.0
65	65	6.0 CA	5.62	8.59	21.9	35.8	87.7
		5.0 CA	4.52	4.26	22.2	36.2	88.6
		4.0 CA	3.69	2.26	22.3	36.4	89.2
75	75	8.0 CA	8.59	23.4	25.1	41.0	100
		6.0 CA	6.56	10.0	25.5	41.6	102
		5.0 CA	5.26	4.93	25.7	41.9	103
		4.0 CA	4.29	2.63	25.8	42.2	103
90	90	8.0 CA	10.5	28.5	30.4	49.7	122
		5.0 CA	6.37	5.97	31.0	50.6	124
100	100	8.0 CA	11.7	31.9	33.9	55.4	136
		6.0 CA	8.92	13.6	34.3	56.0	137
125	125	8.0 CA	14.9	40.4	42.8	69.9	171
		5.0 CA	8.95	8.39	43.4	70.8	173
		4.0 CA	7.27	4.46	43.5	71.1	174
150	150	8.0 CA	18.0	49.0	51.6	84.3	206
		5.0 CA	10.8	10.1	52.2	85.2	209

- NOTES :
1. Steel grade C450L0 / C400L0 / C350L0 (for $t \leq 2.5$ mm $f_y = 350$ MPa and $f_u = 400$ MPa, for 2.5 mm $< t \leq 6.0$ mm $f_y = 450$ MPa and $f_u = 500$ MPa, and for $t > 6.0$ mm $f_y = 400$ MPa and $f_u = 450$ MPa).
 2. With the exception of J, properties are calculated assuming a simplified shape where the bends are eliminated and the section is represented by straight mid-lines in accordance with Clause 2.1.2.1 of AS/NZS 4600.
 3. D_y is zero for equal angles.
 4. I_w is equal to zero for angles.
 5. The shear centre is assumed to be located at the intersection of the centre lines of the angle legs.
 6. Sizes shown in Italics may not be stocked at the intersection of the centre lines of the angle legs.
 7. * are also available as DuraGal®Plus(Lintels). Refer to the Product Information section at the front of this publication.

Equal Angle Sections



Japmas Equal Angle Sections Dimensions And Full Section Properties Grade C400L0/C450L0 About Principal X- And Y-axes

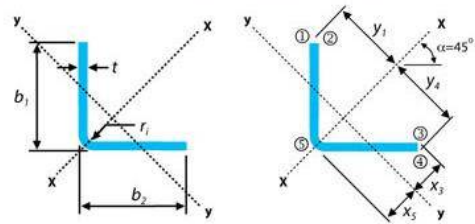

DIMENSIONS									SECTION PROPERTIES									
Designation Leg Size b ₁ b ₂	Nominal Thick- ness	Mass per metre	Actual Thick- ness t	Inside Corner Radius r ₁	Co-ordinates of Centroid			Full Area of Section A _y	About x-axis				About y-axis					
					y ₁ = y ₄	x ₂ = x ₃	x ₅		I _x	Z _{x1} = Z _{x4}	S _x	r _x	I _y	Z _{y2} = Z _{y3}	Z _{y5}	S _y	r _y	
mm	mm	kg/m	mm	mm	mm	mm	mm	mm ²	10 ⁶ mm ⁴	10 ³ mm ³	10 ³ mm ³	mm	10 ⁶ mm ⁴	10 ³ mm ³	10 ³ mm ³	10 ³ mm ³	mm	
30 x 30 x 2.5 CA		1.06	2.4	2.5	21.2	10.7	10.2	134	0.0191	0.902	1.40	11.9	0.00438	0.408	0.431	0.431	5.71	
40 x 40 x 4.0 CA		2.20	3.8	4.0	28.3	14.3	13.4	280	0.0702	2.48	3.89	15.8	0.0157	1.10	1.17	1.82	7.50	
40 x 40 x 2.5 CA		1.43	2.4	2.5	28.3	14.3	13.7	182	0.0468	1.65	2.55	16.0	0.0110	0.765	0.801	1.22	7.75	
45 x 45 x 4.0 CA		2.50	3.8	4.0	31.8	16.1	15.2	318	0.102	3.19	4.98	17.9	0.0231	1.43	1.52	2.35	8.52	
45 x 45 x 2.5 CA		1.62	2.4	2.5	31.8	16.0	15.4	206	0.0673	2.11	3.25	18.1	0.0159	0.990	1.03	1.57	8.77	
50 x 50 x 6.0 CA		4.21	6.0	8.0	35.4	17.8	16.0	536	0.208	5.89	9.29	19.7	0.0434	2.44	2.71	4.18	9.00	
50 x 50 x 5.0 CA		3.42	4.7	4.0	35.4	18.0	17.1	435	0.170	4.80	7.53	19.8	0.0389	2.16	2.28	3.56	9.45	
50 x 50 x 4.0 CA		2.79	3.8	4.0	35.4	17.9	16.9	356	1.141	3.99	6.20	19.9	0.0324	1.81	1.91	2.94	9.54	
50 x 50 x 2.5 CA		1.81	2.4	2.5	35.4	17.8	17.2	230	0.0930	2.63	4.04	20.1	0.0221	1.24	1.28	1.95	9.79	
65 x 65 x 6.0 CA		5.62	6.0	8.0	46.0	23.1	21.3	716	0.477	10.4	16.2	25.8	0.104	4.52	4.91	7.50	12.1	
65 x 65 x 5.0 CA		4.52	4.7	4.0	46.0	23.3	22.4	576	0.386	8.39	13.0	25.9	0.0902	3.87	4.03	6.24	12.5	
65 x 65 x 4.0 CA		3.69	3.8	4.0	46.0	23.2	22.2	470	0.318	6.93	10.7	26.0	0.0747	3.22	3.36	5.13	12.6	
75 x 75 x 8.0 CA		8.59	8.0	8.0	53.0	26.9	25.1	1090	0.957	18.0	28.4	29.6	0.213	7.89	8.46	13.2	13.9	
75 x 75 x 6.0 CA		6.56	6.0	8.0	53.0	26.7	24.8	836	0.757	14.1	21.9	29.9	0.167	6.26	6.73	10.2	14.1	
75 x 75 x 5.0 CA		5.26	4.7	4.0	53.0	26.8	25.9	670	0.601	11.3	17.5	30.0	0.142	5.29	5.48	8.44	14.6	
75 x 75 x 4.0 CA		4.29	3.8	4.0	53.0	26.7	25.8	546	0.495	9.34	14.3	30.1	0.117	4.39	4.55	6.93	14.7	
90 x 90 x 8.0 CA		10.5	8.0	8.0	63.6	32.3	30.4	1330	1.70	26.7	41.7	35.7	0.386	12.0	12.7	19.7	17.0	
90 x 90 x 5.0 CA		6.37	4.7	4.0	63.6	32.2	31.2	811	1.06	16.6	25.5	36.1	0.252	7.83	8.06	12.4	17.6	
100 x 100 x 8.0 CA #		11.7	8.0	8.0	70.7	35.8	33.9	1490	2.36	33.4	52.0	39.8	0.542	15.1	16.0	24.7	19.0	
100 x 100 x 6.0 CA #		8.92	6.0	8.0	70.7	35.5	33.6	1140	1.83	25.8	39.8	40.1	0.421	11.9	12.5	19.0	19.3	
125 x 125 x 8.0 CA		14.9	8.0	8.0	88.4	44.6	42.8	1890	4.73	53.5	82.7	50.0	1.11	24.7	25.8	39.6	24.1	
125 x 125 x 5.0 CA		8.95	4.7	4.0	88.4	44.5	43.6	1140	2.89	32.7	50.0	50.4	0.699	15.7	16.0	24.4	24.8	
125 x 125 x 4.0 CA		7.27	3.8	4.0	88.4	44.4	43.4	926	2.36	26.7	40.7	50.5	0.572	12.9	13.2	19.9	24.9	
150 x 150 x 8.0 CA		18.0	8.0	8.0	106	53.5	53.5	2290	8.30	78.3	120	60.2	1.96	36.7	38.1	58.2	29.3	
150 x 150 x 5.0 CA		10.8	4.7	4.0	106	53.4	53.4	1380	5.04	47.6	72.4	60.6	1.23	23.0	23.4	35.6	29.9	

NOTES : 1. Steel grade C450L0 / C400L0 / C350L0 (for t ≤ 2.5 mm f_y = 350 MPa and f_u = 400 MPa, for 2.5 mm < t ≤ 6.0 mm f_y = 450 MPa and f_u = 500 MPa, and for t > 6.0 mm f_y = 400 MPa and f_u = 450 MPa).
 2. Full section properties are calculated in accordance with AS/NZS 4600.
 3. Sizes shown in Italics may not be stocked in all states or minimum order quantities may apply.
 4. # are also available as DuraGal®Plus(Lintels). Refer to the Product Information section at the front of this publication.



Equal Angle Sections

Japmas Equal Angle Sections Effective Section Properties Grade C40010/c45010 About Principal X- And Y-axes

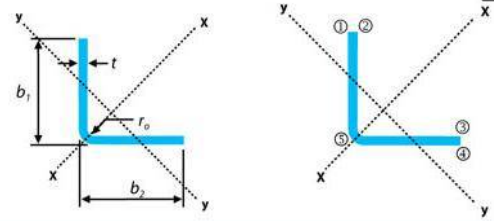

DIMENSIONS					RATIOS		GRADE	EFFECTIVE SECTION PROPERTIES										
Designation Leg b ₁	Nominal Size b ₂	Thick- ness	Mass per metre	Actual Thick- ness t	Outside Corner Radius r ₀	$\frac{b_1 - r_0}{t}$	$\frac{b_2 - r_0}{t}$	Yield Stress f _y	Effective Area of Section A _e	$\frac{A_e}{A_l}$	About x-axis				About y-axis			
											L _{ex1} = L _{ex4}	Z _{x1} = Z _{ex4}	L _{ey2,3}	Z _{ey2,3}	L _{ey5}	Z _{ey5}		
mm	mm	mm	kg/m	mm	mm			MPa	mm ²		10 ⁶ mm ⁴	10 ³ mm ³	10 ⁶ mm ⁴	10 ³ mm ³	10 ⁶ mm ⁴	10 ³ mm ³		
30 x 30 x 2.5 CA			1.06	2.4	4.9	10.5	10.5	350	132	0.980	0.0191	0.902	0.00438	0.408	0.00438	0.408		
40 x 40 x CA	2.5 CA		2.20	3.8	7.8	8.47	8.47	450	280	1.00	0.0702	2.48	0.0157	1.10	0.0157	1.10		
			1.43	2.4	4.9	14.6	14.6	350	147	0.806	0.0385	1.45	0.0104	0.740	0.0110	0.768		
45 x 45 x 4.0 CA	2.5 CA		2.50	3.8	7.8	9.79	9.79	450	303	0.952	0.102	3.19	0.0231	1.42	0.0231	1.43		
			1.62	2.4	4.9	16.7	16.7	350	152	0.736	0.0494	1.71	0.0135	0.884	0.0159	0.990		
50 x 50 x 6.0 CA			4.21	6.1	14.0	6.00	6.00	450	536	1.00	0.208	5.89	0.0434	2.44	0.0434	2.44		
	5.0 CA		3.42	4.7	8.7	8.79	8.79	450	435	1.00	0.170	4.80	0.0389	2.16	0.0389	2.16		
	4.0 CA		2.79	3.8	7.8	11.1	11.1	450	316	0.888	0.131	3.78	0.0324	1.81	0.0324	1.81		
	2.5 CA		1.81	2.4	4.9	18.8	18.8	350	156	0.676	0.0615	1.98	0.0169	1.03	0.0221	1.24		
65 x 65 x 6.0 CA			5.62	6.0	14.0	8.50	8.50	450	716	1.00	0.477	10.4	0.104	4.52	0.104	4.52		
	5.0 CA		4.52	4.7	8.7	12.0	12.0	450	487	0.846	0.337	7.65	0.0902	3.87	0.0902	3.87		
	4.0 CA		3.69	3.8	7.8	15.1	15.1	450	342	0.727	0.230	5.54	0.0619	2.83	0.0747	3.22		

DIMENSIONS					RATIOS		GRADE	EFFECTIVE SECTION PROPERTIES										
Designation Leg b ₁	Nominal Size b ₂	Thick- ness	Mass per metre	Actual Thick- ness t	Outside Corner Radius r ₀	$\frac{b_1 - r_0}{t}$	$\frac{b_2 - r_0}{t}$	Yield Stress f _y	Effective Area of Section A _e	$\frac{A_e}{A_l}$	About x-axis				About y-axis			
											L _{ex1} = L _{ex4}	Z _{x1} = Z _{ex4}	L _{ey2,3}	Z _{ey2,3}	L _{ey5}	Z _{ey5}		
mm	mm	mm	kg/m	mm	mm			MPa	mm ²		10 ⁶ mm ⁴	10 ³ mm ³	10 ⁶ mm ⁴	10 ³ mm ³	10 ⁶ mm ⁴	10 ³ mm ³		
75 x 75 x 8.0 CA			8.59	8.0	16.0	7.38	7.38	400	1090	1.00	0.957	18.0	0.213	7.09	0.213	7.89		
	6.0 CA		6.56	6.0	14.0	10.2	10.2	450	781	0.934	0.735	13.9	0.167	6.26	0.167	6.26		
	5.0 CA		5.26	4.7	8.7	14.1	14.1	450	508	0.759	0.458	9.41	0.125	4.84	0.142	5.29		
	4.0 CA		4.29	3.8	7.8	17.7	17.7	450	353	0.646	0.310	6.78	0.0840	3.49	0.117	4.39		
90 x 90 x 8.0 CA			10.5	8.0	16.0	9.25	9.25	400	1320	1.00	1.70	26.7	0.386	12.0	0.386	12.0		
	5.0 CA		6.37	4.7	8.7	17.3	17.3	450	530	0.654	0.672	12.2	0.185	6.33	0.252	7.83		
100 x 100 x 8.0 CA			11.7	8.0	16.0	10.5	10.5	400	1410	0.946	2.36	33.4	0.542	15.1	0.542	15.1		
	6.0 CA		8.92	6.0	14.0	14.3	14.3	450	859	0.756	1.38	21.3	0.363	10.7	0.421	11.9		
125 x 125 x 8.0 CCA			14.9	8.0	16.0	13.6	13.6	400	1530	0.809	3.90	46.9	1.05	23.9	1.11	24.7		
	5.0 CA		8.95	4.7	8.7	24.7	24.7	450	560	0.491	1.34	19.4	0.368	10.2	0.699	15.7		
	4.0 CA		7.27	3.8	7.8	30.8	30.8	450	379	0.409	0.917	14.0	0.248	7.31	0.572	12.9		
150 x 150 x 8.0 CA			18.0	8.0	16.0	15.8	16.8	400	1610	0.701	5.74	60.8	1.56	31.4	1.96	36.7		
	5.0 CA		10.8	4.7	8.7	30.1	30.1	450	572	0.416	1.99	25.3	0.544	13.2	1.23	23.0		

- NOTES : 1. Steel grade C450L0 / C400L0 / C350L0 (for t ≤ 2.5 mm f_y = 350 MPa and f_u = 400 MPa, for 2.5 mm < t ≤ 6.0 mm f_y = 450 MPa and f_u = 500 MPa, and for t > 6.0 mm f_y = 400 MPa and f_u = 450 MPa).
2. A_e is calculated for sections with uniform axial compressive stress f_y.
3. I_{ex} and Z_{ex} are calculated with the extreme compression or tension fibres at f_y (first yield). Z_{ex} is calculated at the extreme tension or compression fibre of the effective section.
4. I_{ex1} and Z_{ex1} are for compression at point "1"; I_{ex4} and Z_{ex4} are for compression at point "4"; I_{ey2,3} and Z_{ey2,3} are for compression at points "2" and "3"; I_{ey5} and Z_{ey5} are for compression at point "5".
5. Effective section properties are calculated in accordance with AS/NZS 4600.
6. Sizes shown in Italics may not be stocked in all states or minimum order quantities may apply.
7. * are also available as DuraGal®Plus(Lintels). Refer to the Product Information section at the front of this publication.

Unequal Angle Sections



Dimensions And Full Section Properties Grade C400L0/C450L0 (Ts 100) About Principal X- And Y-axes

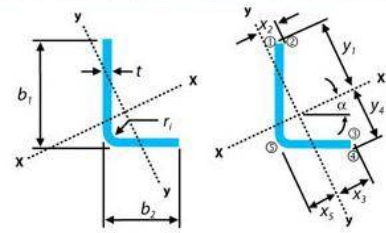

DIMENSIONS											
Designation	Mass per metre	Actual Thickness	Inside Corner Radius	Coordinates of Centroid					Tan α		
Leg Size	Nominal Thickness	t	r_1	r_1	y_4	x_2	x_3	x_5			
b_1	b_2	mm	mm	mm	mm	mm	mm	mm	mm		
75 x 50 x 6.0 CA	5.38	6.0	8.0	50.0	39.2	14.9	25.3	17.8	0.472		
	5.0 CA	4.34	4.7	4.0	50.6	38.4	14.4	26.1	18.5	0.462	
	4.0 CA	3.54	3.8	4.0	50.8	38.3	14.1	26.1	18.3	0.464	
100 x 75 x 8.0 CA	10.2	8.0	8.0	68.3	55.8	23.6	35.8	27.4	0.576		
	6.0 CA	7.74	6.0	8.0	68.6	55.5	23.1	35.8	27.0	0.578	
125 x 75 x 8.0 CA [#]	11.7	8.0	8.0	82.6	61.0	20.6	40.9	27.2	0.386		
	6.0 CA	8.92	6.0	8.0	83.1	60.6	19.9	41.2	26.8	0.388	
150 x 100 x 8.0 CA [#]	14.9	8.0	8.0	101	76.6	28.4	52.2	36.7	0.463		
	6.0 CA	11.3	6.0	8.0	102	76.3	27.8	52.3	36.3	0.465	

SECTION PROPERTIES															
Designation	Mass per metre	Full Area of Section	About x-axis							About y-axis					
Leg Size	Nominal Thickness	A_t	I_x	Z_{x1}	Z_{x4}	S_x	r_x	I_y	Z_{y2}	Z_{y3}	Z_{y5}	S_y	r_y		
b_1	b_2	mm ²	10 ⁹ mm ⁴	10 ³ mm ³	10 ³ mm ³	10 ³ mm ³	mm	10 ⁹ mm ⁴	10 ³ mm ³	10 ³ mm ³	10 ³ mm ³	10 ³ mm ³	mm	mm	
75 x 50 x 6.0 CA	5.38	686	0.464	9.29	11.9	15.7	26.0	0.0731	4.89	2.89	4.10	5.97	10.3		
	5.0 CA	4.34	553	0.378	7.47	9.83	12.7	26.2	0.0631	4.38	2.42	3.42	4.96	10.7	
	4.0 CA	3.54	451	0.312	6.15	8.15	10.4	26.3	0.0524	3.71	2.01	2.87	4.08	10.8	
100 x 75 x 8.0 CA	10.2	1290	1.64	24.0	29.4	40.4	35.6	0.312	13.2	8.72	114.4	17.1	15.5		
	6.0 CA	7.74	986	1.27	18.6	22.9	31.1	36.0	0.244	10.6	6.81	9.03	13.2	15.7	
125 x 75 x 8.0 CA [#]	11.7	1490	2.74	33.1	44.8	56.2	42.8	0.381	18.5	9.30	14.0	19.8	16.0		
	6.0 CA	8.92	1140	2.11	25.4	34.9	43.0	43.1	0.297	14.9	7.21	11.1	15.2	16.2	
150 x 100 x 8.0 CA [#]	14.9	1890	5.23	51.5	68.3	87.3	52.5	0.878	30.9	16.8	23.9	34.2	21.5		
	6.0 CA	11.3	1440	4.02	39.4	52.7	66.6	52.9	0.679	24.4	13.0	18.7	26.2	21.7	

NOTES : 1. Steel grade C450L0 / C400L0 (for $t \leq 2.5$ mm $f_y = 350$ MPa and $f_u = 400$ MPa, for 2.5 mm $< t \leq 6.0$ mm $f_y = 450$ MPa and $f_u = 500$ MPa, and for $t > 6.0$ mm $f_y = 400$ MPa and $f_u = 450$ MPa).
 2. Full section properties are calculated in accordance with AS/NZS 4600.
 3. Sizes shown in Italics may not be stocked in all states or minimum order quantities may apply.
 7. [#] are also available as DuraGal[®]Plus(Lintels). 150 x 10 x 6.0 CA is a preferred Lintel size. Refer to the Product Information section at the front of this publication.



Unequal Angle Sections

Section Properties For Member Stability Grade C400L0/C450L0 (Ts 100) About Principal X- And Y-axes

DIMENSIONS									
Designation			Mass per metre	Torsion Constant	Coordinate of Shear Centre		Polar Radius of Gyration about the Shear Centre	Monosymmetry Section Constant	
Leg	Size	Nominal Thickness			X_o	Y_o		β_x	β_y
b_1	b_2	mm	kg/m	10^3mm^4	mm	mm	mm	mm	mm
	75 x 50 x 6.0 CA	5.38	8.23	17.3	16.2	36.6	39.2	79.2	
	5.0 CA	4.34	4.07	17.6	16.2	36.9	39.2	80.2	
	4.0 CA	3.54	2.17	17.7	16.2	37.2	39.2	80.8	
	100 x 75 x 8.0 CA	10.2	27.6	26.6	16.8	49.8	41.3	114	
	6.0 CA	7.74	11.8	27.0	16.8	50.4	41.3	115	
	125 x 75 x 8.0 CA#	11.7	31.9	25.5	31.2	60.8	74.7	126	
	6.0 CA	8.92	13.6	25.9	31.3	61.3	74.9	127	
	150 x 100 x 8.0 CA#	14.9	40.7	35.4	32.4	74.2	78.6	161	
	6.0 CA	11.3	17.2	35.8	32.4	74.7	78.7	163	

- NOTES : 1. Steel grade C450L0 / C400L0 / (for $t \leq 2.5 \text{ mm}$ $f_y = 350 \text{ MPa}$ and $f_u = 400 \text{ MPa}$, for $2.5 \text{ mm} < t \leq 6.0 \text{ mm}$ $f_y = 450 \text{ MPa}$ and $f_u = 500 \text{ MPa}$, and for $t > 6.0 \text{ mm}$ $f_y = 400 \text{ MPa}$ and $f_u = 450 \text{ MPa}$).
2. With the exception of J, properties are calculated assuming a simplified shape where the bends are eliminated and the section is represented by straight mid-lines in accordance with Clause 2.1.2.1 of AS/NZS 4600.
3. J is equal to zero for angles.
4. The shear centre is assumed to be located at the intersection of the centre lines of the angle legs.
5. Sizes shown in Italics may not be stocked in all states or minimum order quantities may apply.
7. # are also available as DuraGal®Plus(Lintels). 150 x 10 x 6.0 CA is a preferred Lintel size. Refer to the Product Information section at the front of this publication.

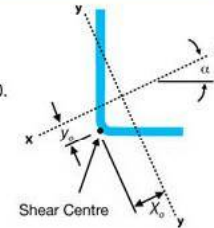

Effective Section Properties

DIMENSIONS				RATIOS		GRADE	EFFECTIVE SECTION PROPERTIES											
Leg	Size	Nominal Thickness	Mass per metre	Actual Thickness	Outside Corner Radius	$\frac{b_1 - r_o}{t}$	$\frac{b_2 - r_o}{t}$	Yield Stress	Effective Area of Section	$\frac{A_e}{A_y}$	About x-axis				About y-axis			
											I_{ex1}	Z_{x1}	I_{ex4}	Z_{ex4}	$I_{ey2,3}$	$Z_{ey2,3}$	I_{ey5}	Z_{ey5}
mm	mm	mm	kg/m	mm	mm			MPa	mm ²		10^6mm^4	10^3mm^3	10^6mm^4	10^3mm^3	10^6mm^4	10^3mm^3	10^6mm^4	10^3mm^3
	75 x 50 x 6.0 CA	5.38	6.0	14.0	10.2	6.00	450	658	0.960	0.464	9.29	0.464	9.29	0.0731	2.89	0.0731	2.89	
	5.0 CA	4.34	4.7	8.7	14.1	8.79	450	472	0.854	0.286	6.17	0.375	7.47	0.0631	2.42	0.0631	2.42	
	4.0 CA	3.54	3.8	7.8	17.7	11.1	450	334	0.741	0.185	4.30	0.309	6.10	0.0520	1.99	0.0524	2.01	
	100 x 75 x 8.0 CA	10.2	8.0	16.0	10.5	7.38	400	1250	0.969	1.64	24.0	1.64	24.0	0.312	8.72	0.312	8.72	
	6.0 CA	7.74	6.0	14.0	14.3	10.2	450	820	0.832	0.936	15.0	1.27	18.6	0.244	6.81	0.244	6.81	
	125 x 75 x 8.0 CA#	11.7	8.0	16.0	13.6	7.39	400	1310	0.879	2.30	29.4	2.74	33.1	0.381	9.30	0.381	9.30	
	6.0 CA	8.92	6.0	14.0	18.5	10.2	450	841	0.741	1.20	17.3	2.11	25.4	0.295	7.13	0.297	7.21	
	150 x 100 8.0 CA#	14.9	8.0	16.0	16.8	10.5	400	1510	0.797	3.52	39.2	5.23	51.5	0.878	16.8	0.678	16.8	
	6.0 CA	11.3	6.0	14.0	22.7	14.3	450	894	0.623	1.82	22.9	3.59	36.8	0.539	11.2	0.679	13.0	

- NOTES : 1. Steel grade C450L0 / C400L0 (for $t \leq 2.5 \text{ mm}$ $f_y = 350 \text{ MPa}$ and $f_u = 400 \text{ MPa}$, for $2.5 \text{ mm} < t \leq 6.0 \text{ mm}$ $f_y = 450 \text{ MPa}$ and $f_u = 500 \text{ MPa}$, and for $t > 6.0 \text{ mm}$ $f_y = 400 \text{ MPa}$ and $f_u = 450 \text{ MPa}$).
2. A_e is calculated for sections with uniform axial compressive stress f_y .
3. I_e and Z_e are calculated with the extreme compression or tension fibres at f_y (first yield). Z_e is calculated at the extreme tension or compression fibre of the effective section.
4. I_{ex1} and Z_{ex1} are for compression at point "1"; I_{ex4} and Z_{ex4} are for compression at point "4"; $I_{ey2,3}$ and $Z_{ey2,3}$ are for compression at points "2" and "3"; I_{ey5} and Z_{ey5} are for compression at point "5".
5. Effective section properties are calculated in accordance with AS/NZS 4600.
6. Sizes shown in Italics may not be stocked in all states or minimum order quantities may apply.
7. # are also available as DuraGal®Plus(Lintels). 150 x 10 x 6.0 CA is a preferred Lintel size. Refer to the Product Information section at the front of this publication.

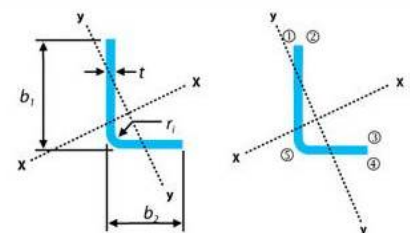

High-Tensile GI-Purlins

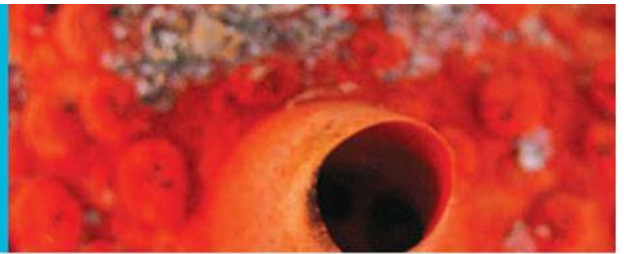

33

High-Tensile GI Purlins

All Japmas purlins are cold-formed from high-tensile zinc as well as other high anti-corrosion alloyed-coated steel, eg SUPERDYMA, which conform to international standard and supplied in custom length coupled with pre-punched holes. This obviates any fabrication and painting at site in no longer required and ready for immediate erection upon delivery. Japmas purlins are lightweight, high strength, versatile, economical and require minimal maintenance.

Material Specifications

Base Steel Thickness:	1.6mm, 2.0mm, 2.5mm (other thickness up to 6mm is also available upon request)
Steel Grade:	High tensile ASTM A446 Grade D or equivalent
Tensile Strength:	Min. 450 Mpa
Yield Stress:	Min. 350 Mpa
Zinc Coating:	Min. 275 g/m coating mass on both surface.

Tolerances:

Depth:	+/- 1.0mm
Flange Width:	+/- 2.0mm
Overall Length:	+/- 3.0mm
Hole-Centre:	+/- 1.5mm
Lips Width:	+/- 2.0mm





High-Tensile GI-Purlins

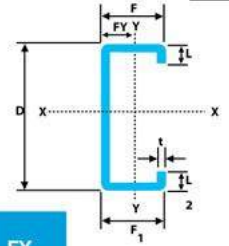

PURLIN C-SECTION

C Section Identification	Section Dimensions				Area mm ²	Mass Per Unit Length kg/m	Second Moment Of Area		Second Modulus		Radius Of Gyration		FY mm
	D	F	L	t			I _x	I _y	Z _x	Z _y	R _x	R _y	
	mm	mm	mm	mm			10 ⁶ mm ⁴	10 ⁶ mm ⁴	10 ³ mm ³	10 ³ mm ³	mm	mm	
JCP 1016	102	51	16	1.6	373	3.05	0.60	0.14	11.77	4.11	40.6	19.5	18.24
JCP 1020	102	51	16	2.0	442	3.72	0.76	0.18	14.84	5.46	41.9	20.3	18.60
JCP 1025	102	51	16	2.5	534	4.60	0.95	0.22	18.56	7.01	42.7	20.9	19.05
JCP 1216	127	51	16	1.6	408	3.20	1.00	0.15	15.72	4.29	50.0	21.4	11.08
JCP 1220	127	51	16	2.0	510	3.94	1.25	0.19	19.67	5.49	50.1	21.5	16.42
JCP 1225	127	51	16	2.5	638	4.89	1.56	0.24	24.56	7.13	50.1	21.6	17.35
JCP 1516	153	71	16	1.6	512	4.01	1.99	0.34	26.30	6.90	62.3	25.8	21.69
JCP 1520	153	71	16	2.0	598	4.92	2.48	0.41	32.42	8.61	64.4	26.2	23.36
JCP 1525	153	71	16	2.5	731	6.01	3.11	0.50	40.65	10.24	65.2	26.3	24.11
JCP 1716	175	71	16	1.6	539	4.27	2.63	0.34	29.70	7.00	69.8	25.2	18.05
JCP 1720	175	71	16	2.0	670	5.26	3.25	0.45	35.33	8.93	69.6	25.8	18.48
JCP 1725	175	71	16	2.5	835	6.67	4.04	0.54	45.45	10.85	69.6	25.9	19.20
JCP 2016	203	71	16	1.6	572	4.70	3.80	0.37	37.44	7.09	80.8	25.1	19.18
JCP 2020	203	71	16	2.0	698	5.74	4.75	0.45	46.80	9.39	82.5	25.4	20.16
JCP 2025	203	71	16	2.5	855	7.03	5.94	0.61	58.52	12.23	83.4	26.8	20.80
JCP 2520	250	78	18	2.0	840	6.59	7.63	0.58	61.08	10.08	95.3	26.3	18.83
JCP 2525	250	78	18	2.5	1050	8.24	9.52	0.73	76.18	12.85	95.2	26.4	18.85

D = DEPTH F = FLANGE L = LIPPED t = THICKNESS

* The Thickness also available upon special request.

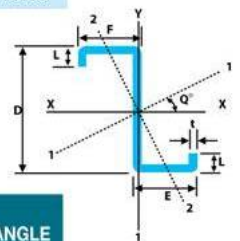

PURLIN Z-SECTION

Z Section Identification	Section Dimensions					Area mm ²	Mass Per Unit Length kg/m	Second Moment Of Area		Second Modulus		Radius Of Gyration		1-1 AXIS	2-2 AXIS	ANGLE DEG
	D	E	F	L	t			I _x	I _y	Z _x	Z _y	R _x	R _y	I 1	I 2	
	mm	mm	mm	mm	mm			10 ⁶ mm ⁴	10 ⁶ mm ⁴	10 ³ mm ³	10 ³ mm ³	mm	mm	10 ⁶ mm ⁴	10 ⁶ mm ⁴	
JZP 1016	102	57	51	16	1.6	373	3.05	0.62	0.250	12.16	4.94	40.60	25.80	0.70	0.160	24.5
JZP 1020	102	57	51	16	2.0	442	3.72	0.77	0.310	15.14	6.22	41.80	26.50	0.98	0.190	24.4
JZP 1025	102	57	51	16	2.5	534	4.60	0.98	0.380	18.84	7.60	42.40	26.60	1.11	0.230	24.3
JZP 1216	127	57	51	16	1.6	408	3.20	1.03	0.261	16.18	5.20	50.10	25.30	1.30	0.351	22.7
JZP 1220	127	57	51	16	2.0	510	3.94	1.28	0.380	20.16	7.60	51.10	27.30	1.63	0.434	22.6
JZP 1225	127	57	51	16	2.5	638	4.89	1.60	0.470	25.20	9.45	52.20	27.50	2.32	0.335	23.3
JZP 1516	153	74	67.5	16	1.6	512	4.01	2.01	0.646	26.30	9.69	62.70	35.50	2.32	0.335	23.3
JZP 1520	153	74	67.5	16	2.0	598	4.92	2.50	0.811	32.70	12.20	65.40	37.20	2.86	0.451	22.7
JZP 1525	153	74	67.5	16	2.5	731	6.01	3.12	1.031	40.70	15.60	66.20	38.10	3.53	0.619	22.1
JZP 1716	175	74	67.5	16	1.6	539	4.27	2.64	0.507	29.83	6.98	69.98	30.60	-	-	-
JZP 1720	175	74	67.5	16	2.0	670	5.26	3.27	0.620	36.95	8.70	69.86	30.40	-	-	-
JZP 1725	175	74	67.5	16	2.5	835	6.67	4.04	0.755	45.65	9.90	69.56	30.10	-	-	-
JZP 2016	203	74	67.5	16	1.6	572	4.70	3.86	0.635	38.10	9.52	82.60	33.50	4.15	0.350	15.9
JZP 2020	203	74	67.5	16	2.0	698	5.71	4.85	0.811	47.80	12.20	84.10	34.40	5.16	0.501	15.0
JZP 2025	203	74	67.5	16	2.5	855	7.03	6.05	1.021	59.60	15.40	85.10	34.90	6.40	0.675	14.2
JZP 2520	250	78	72	20	2.0	840	6.59	7.67	0.85	61.32	11.07	95.53	31.86	-	-	-
JZP 2525	250	78	72	21	2.5	1050	8.24	9.52	1.08	76.18	14.01	95.23	32.00	-	-	-

D = DEPTH F = NARROW FLANGE E = BROAD FLANGE L = LIPPED t = THICKNESS

12" and special thickness also available upon request.

ULTRADEK-762®



ULTRADEK-762® is a light weight steel roofing and cladding profile with improved water tight design with anti-capillary groove and internal valley. ULTRADEK-762® is produced in length up to 12M, longer length is available provided transport and on-site handling can be arranged. Site forming of ULTRADEK-762® is also available upon request for large scale project.

MATERIALS

ULTRADEK-762® is readily available in BlueScope Zincalume® steel and BlueScope Clean COLORBOND® steel. Moreover, other materials listed below are also available for project with specific requirement upon request. ULTRADEK-762® has back to back material performance warranty from reputable steel mills upon meeting all the requirements.

- PPGL manufactured in accordance to JIS 3312/ASTM A653;
- BlueScope Clean COLORBOND ULTRA® AZ200 G550 and PrimaMaju™ AZ100 G500;
- Nippon SuperDyma® NSDC570.

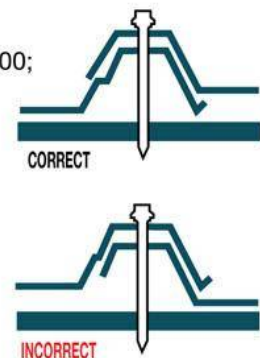
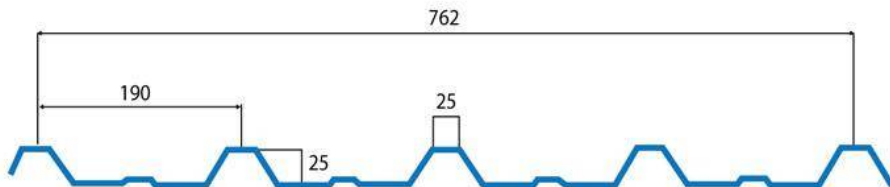

ULTRADEK-762® can be used on roof pitches as low as 3° (without end-laps).

TOLERANCES: Length +/- 10mm, Cover width +/- 4mm

SIDE LAPPING

The correct side overlap ensures 100% water leakage proof and enhance unique ULTRADEK-762® appearance.

PHYSICAL PROPERTIES

Total Coated Thickness	Zincalume®			Clean COLORBOND®		
	kg/m	kg/m ²	m ² /mt	kg/m	kg/m ²	m ² /mt
0.40mm	2.73	3.58	279	2.8	3.68	272
0.47mm	3.28	4.30	232	3.34	4.39	228

CAPACITY & LOAD

Span Between Support / mm	0.40mm TCT		0.47mm TCT	
	Loading (KN/m ²)	Deflection/mm	Loading (KN/m ²)	Deflection/mm
850	260	1.80	500	2.8
1,000	190	2.60	380	4.1
1,150	145	3.40	280	5.3
1,300	110	4.20	220	6.8
1,450	90	5.50	180	8.6
1,600	75	6.60	140	10.0

RECOMMENDED SPANNING

Total Coated Thickness	Roofing			Walling		
	Single	End	Internal	Single	End	Internal
0.40mm	800	900	1200	1200	1300	1500
0.47mm	940	1040	1500	1500	1800	2000



ULTRADEK-1018[®]

ULTRADEK-1018[®] is an aesthetic profile which gives greater cost cuttings resulted by its wider spanning capability that helps to reduce steel uses for roofing support. Fewer overlaps and joints promote shorter time and lesser manpower for installation as well as the advanced water-tight design also exceptionally reflected. ULTRADEK-1018[®] is economical to use in most building projects for roofing, walling and fencing application. ULTRADEK-1018[®] is readily available in BlueScope Zinalume[®] steel and BlueScope Clean COLORBOND[®] steel. Moreover, other materials listed below are also available for project with specific requirement upon request. ULTRADEK-1018[®] has back to back material performance warranty from reputable steel mills upon meeting all the requirements

- PPGI manufactured in accordance to JIS 3312/ASTM A653;
- BlueScope Clean COLORBOND ULTRA[®] AZ200 G550 and PrimaMaju[™] AZ100 G500;
- Nippon SuperDyma[®] NSDC570.

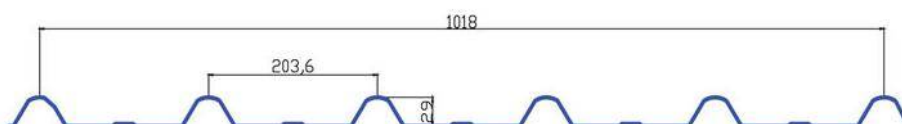

Creast fixing for roofs



Valley fixing for walls only

ULTRADEK-1018[®] can be used on roof pitches as low as 2° (without end-laps).

TOLERANCES: Length +/- 15mm, Cover width +/- 4mm

PHYSICAL PROPERTIES

	Zinalume [®] Steel	COLORBOND Steel	Zinalume [®] Steel	COLORBOND Steel	Zinalume [®] Steel	COLORBOND Steel
Base Metal Thickness [mm]	0.35		0.42		0.48	
Total Coated Thickness [mm]	0.40		0.47		0.53	
Mass Per Unit Area [kg/m ²]	3.53	3.58	4.19	4.24	4.74	4.80
Mass Per Unit Length [kg/m]	3.58	3.63	4.25	4.30	4.81	4.87
Coverage [m ² /t]	284	280	239	236	211	208

RECOMMENDED SPANNING

Total Coated Thickness [mm]	ROOF			WALL		
	Single Span [mm]	Internal Span [mm]	End Span [mm]	Single Span [mm]	Internal Span [mm]	End Span [mm]
0.40	750	1450	1000	1040	2250	1690
0.47	950	1750	1200	1700	2850	2450
0.53	1300	2100	1400	1900	3000	2650

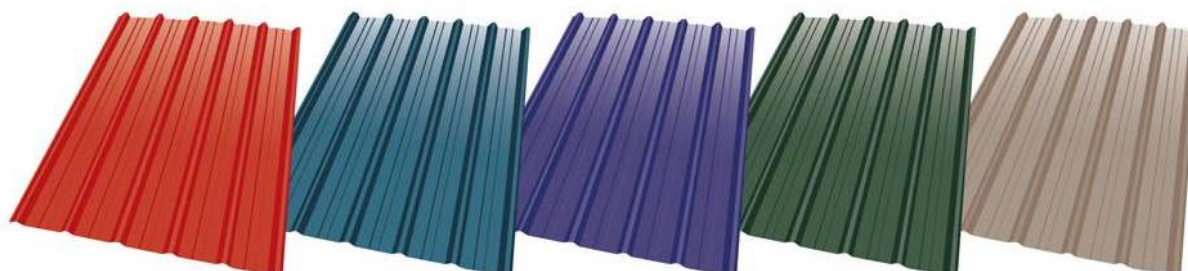

OTHERS

About ULTRADEK-762/-1018[®]



37

ULTRADEK-762/-1018[®] is readily available in popular Clean COLORBOND[®] steel colors. Colour matching is possible upon meeting a minimum order quantity.



Torres Blue



Lazurite Blue



Caulfield Green



Aquamarine



Kiama Blue



Autumn Red



Begie



Almond Begie



Off White



ZINCALUME[®]

FASTENING DETAILS

To match the performance of both ULTRADEK-762/-1018[®], the fasteners must conform to AS3566 Class 3:

CREST FIXING
Drilling Capacity <6.0mm
w/out insulation-CTEKS 12-14 x 50 HGS
with insulation - CTEKS 12-14 x 68 HGS
Hardwood
w/out insulation - CT17 12-11 x 50 HGS
with insulation - CT17 12-11 65 HGS

VALLEY FIXING
Drilling Capacity <6.0mm
w/out insulation-CTEKS 12-14 x 50 HWFS
with insulation - CTEKS 12-14 x 68 HWFS
Hardwood
w/out insulation - CT17 10-12 x 25 HWFS

SIDE FIXING (stitching)
Drilling Capacity <2.5mm
CSP 14-14 x 22 HWFS

ACCESSORIES

Barge Capping, Fascia Capping, Ridge Capping, Valley Gutter, Wall Flashing and other custom-shade capping are also available upon order to match ULTRADEK-762/-1018[®].



Barge Capping



Fascia Capping



Ridge Capping



Valley Gutter



Wall Flashing

Importance Notes

1. Copper and Lead are incompatible materials and should NOT be used in contact with ULTRADEK-762/-1018[®].
2. Use only acetic-free sealant on ULTRADEK-762/-1018[®].
3. Manual cutting is recommended. Avoid circular saw cut that result in having hot particles falling onto ULTRADEK-762/-1018[®].
4. While walking on ULTRADEK-762/-1018[®] roof, evenly distribute weight to avoid concentrating weight on either heels or toes. Use smooth soft soled shoes.

Other steel roofing profiles available for site-forming upon request



Contact us



JAPMAS STEEL SDN. BHD. (196574-X)

PLO 55, Jalan Rumbia 2,
Kawasan Perindustrian Tanjung Langsat,
81700 Pasir Gudang, Johor Bahru, Johor
Malaysia.

Tel : +607 353 7312 (12 lines)
Fax : +607-353 7323 / 7324 / 7002
Email : salesdiv@lcgjapmas.com
Website : www.lcgjapmas.com

Any technical information and variation in this publication are subject to change without prior notice and no warranty as to their suitability for any use in made. Users of this publication are requested to ensure adequacy and accuracy of the information stated herein to satisfy themselves as to its appropriateness. The company cannot accept any responsibility and liability for any loss, damage or consequence resulting from the use of this publication.